

6730018

Model 673, 675, 677



Hot Drink Center II



673p0001

Programming Guide

CRANE MERCHANDISING SYSTEMS A Crane Co. Company
NATIONAL VENDORS

12955 Enterprise Way
Bridgeton, Missouri 63044-1200
(314) 298-3500
www.CraneMS.com

Copyright© 07-03

6730018

This machine has been engineered to our own rigid safety and performance standards. It has been designed to comply with sanitation and health guidelines recommended by the Automatic Merchandising Health-Industry Council (AMHIC) and it conforms with all other NAMA safety recommendations.

This machine has been manufactured in accordance with the safety standards of both Underwriter's Laboratories and the Canadian Standards Association. To maintain this degree of safety and to continue to achieve the level of performance built into this machine, it is important that installation and maintenance be performed so as to not alter the original construction or wiring and that replacement parts are as specified in the Parts Manual. Your investment in this equipment will be protected by using this Setup and Operator's Guide, the Programming Guide, and the Parts Manual in your operation, service and maintenance work. By following prescribed procedures, machine performance and safety will be preserved.

***Crane Merchandising Systems Parts and Support
Phone Numbers:***

**Parts: 1-800-621-7278
Service: 1-800-628-8363**

Table of Contents

| Title | Page |
|--|-----------|
| Introduction | 1 |
| Getting Around | 1 |
| The Displays | 2 |
| The Function Keys | 2 |
| Other Keys | 2 |
| Some Conventions: | 3 |
| Control Panel Switch Functions Explained | 4 |
| SureVend™ | 5 |
| The Supervisor Mode | 6 |
| | |
| Programming Procedures | 7 |
| Basic Setup | 7 |
| Gain Access To The Supervisor Mode | 7 |
| Enter A New Supervisor Code | 7 |
| Enter A Freevend Code | 7 |
| Enter a New Data Recall Code | 8 |
| Lock Or Unlock Mode or Payout Keys | 9 |
| Set Printer or DEX Options | 10 |
| Select Printer Baud Rate | 10 |
| Set DEX Options (DEX Mode Only) | 11 |
| Set Talker Mode | 12 |
| Select Display Language | 12 |
| Select Coin Mechanism | 12 |
| | |
| Monetary Setup | 12 |
| Select Bill Validator | 13 |
| Initial Setup of a Non-Standard Bill Validator | 14 |
| Select Card Reader | 15 |
| Select Monetary Options | 15 |
| Set Up Winner Mode | 18 |
| Set Up Mug Discount | 19 |
| | |
| Cup Configuration | 19 |
| Set the Machine Type and Configuration Code | 20 |
| Disable Selections in the Merchandiser..... | 22 |
| Set Up Cup Sizes | 23 |
| Assign Cup Sizes to Selections..... | 24 |
| Set Up A Hot Drink | 25 |

Table of Contents

| Title | Page |
|--|-----------|
| Set up a Hot Drink | 25 |
| Collecting Dry Product Gram Throws..... | 28 |
| Collecting Hot Water Throws..... | 31 |
| Cappuccino | 33 |
| Caffé Latte | 34 |
| European Cappuccino | 36 |
| Blended Selections | 37 |
| View or Set the Hot Water Tank Temperature | 38 |
| Set up Low Temperature Dispensing | 38 |
| Set up Low Power Settings..... | 39 |
| Set the Automatic Brewer Rinse Time | 40 |
| Set the Bowl Rinse Time | 41 |
| Turn SureVend™ On or Off..... | 42 |
| SureVend Configuration | 42 |
| Optional or Mandatory SureVend™ | 42 |
| Set Up the SureVend™ Anti-Jackpot Timer | 43 |
| View Software Version..... | 43 |
| Set the Time of Day | 44 |
| Setup Time | 44 |
| Set Month, Date, and Year | 44 |
| Set Daylight Savings Option | 44 |
| Set Time-of-Day Inhibit Vending..... | 45 |
| Set Time-of-Day Free Vending | 45 |
| Set Time-of-Day Discount Vending | 45 |
| Time Interval Editing..... | 46 |
| Select a Standby Message..... | 48 |
| Messages | 48 |
| Select an Out-of-Service Message..... | 48 |
| Select a Freevend Message..... | 48 |
| Edit Custom Message | 49 |
| View Water Tank Temperature | 51 |
| Check the Setup | 51 |
| View Machine type/Configuration Setting..... | 51 |
| View Cup Sizes Assigned to Selections | 52 |
| Payout Coins..... | 52 |
| Set Prices | 53 |
| View Nonresettable Sales and Vend Data | 53 |

Table of Contents

| Title | Page |
|---|-----------|
| View Machine Data | 53 |
| View Data Four Different Ways..... | 54 |
| View Total Paid Sales..... | 54 |
| View Total Sales by Drink Size..... | 54 |
| View Total Sales by Selection (both Cup Sizes)..... | 55 |
| View Total Sales by Individual Selection | 55 |
| View Total Paid Sales by Price Line | 55 |
| View Total Paid Vends..... | 56 |
| View Total Paid Vends by Price Line | 56 |
| Clear All Resettable Data | 56 |
| Clear Paid Sales Data Only..... | 57 |
| View Amount in Coin Box..... | 57 |
| View Amount in Validator | 58 |
| View Freevend Sales by Time Interval | 58 |
| View Discount Sales by Time Interval..... | 59 |
| View Free Vends | 59 |
| View Winners | 59 |
| View Time Data..... | 60 |
| View Total Unpaid Sales | 61 |
| View Total Unpaid Vends | 61 |
| View Number of Test Vends | 62 |
| View Number of Mug Vends | 62 |
| View Number of Alt Vends..... | 62 |
| View Machine ID Number | 62 |
| View Cup Ring Cycles Related to SureVend™)..... | 63 |
| View Times No Cup Was Detected After a Cup Ring Cycled..... | 63 |
| View Home Switch Usage Related to SureVend™ | 63 |
| Test Vend Selections and Verify Credit Added | 64 |

Table of Contents

| Title | Page |
|--|-----------|
| Test the Machine | 64 |
| Test Drop a Cup..... | 64 |
| Test the Automatic Delivery Door | 64 |
| Test the Whipper(S)..... | 64 |
| Test the Grinder(S)..... | 65 |
| Test the Air | 65 |
| Test the Brewer..... | 65 |
| Rinse the Mixing Bowls | 65 |
| Rinse the Brewer..... | 66 |
| Test Switches or Sensors | 66 |
| View SureVend™ Last Recorded Calibration Value | 66 |
| View SureVend™ Average Calibration Value..... | 67 |
| Clear Tank Errors and Fill the Tank | 67 |
| Test the Display | 67 |
| View Diagnostic Messages..... | 68 |
| Download Data to a PDCD..... | 70 |
| Set Freevend Options..... | 71 |

GETTING AROUND

Getting around the Hot Drink Center software is pretty easy once you know the features that are available to you, and how to use them. The three main parts you will use are the SERVICE KEYPAD, the SELECTION SWITCH PANEL, and the DISPLAY.

The Service Keypad

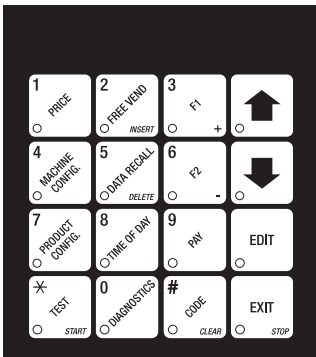

For most of your programming jobs, you will be using the service keypad, conveniently located on the monetary panel. The service keypad has 16 keys. The three columns on the left are the *MODE keys*. *The right hand column contains the MOVEMENT keys*.

The Selection Switch Panel

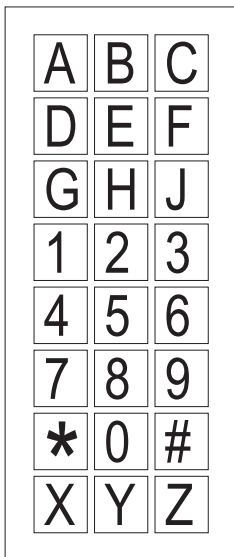

673P0008

The selection switch panel is also located on the monetary panel. Unlike the service keypad, it is accessible when the cabinet door is closed. These are the keys the customer will use to make selections. You can also use these keys during programming procedures.

THE DISPLAYS

The 10-character display performs two functions, and is referred to in this book as "the display":

- It shows the customer's selection and how much credit is in the machine, as well as the ready, service, and time of day messages.
- It provides information and feedback to the service person during maintenance.



THE FUNCTION KEYS

The keys on the control panel can be used for up to three things:

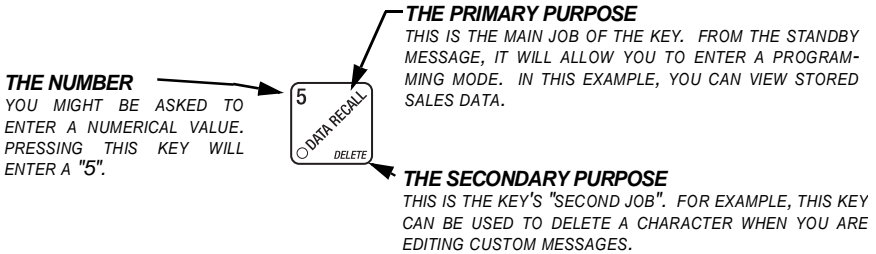

OTHER KEYS

The MOVEMENT keys on the control panel let you move inside a mode, and back and forth between modes.



These keys are your "legs", which let you move up and down the list of tasks. They let you continue from one step to the next in programming procedures.



This is your "activate" or "choose" key. It "opens a door" to additional information and lets you begin a programming task once you are inside of a mode. Sometimes, it is used as a toggle switch to show you your choices during a programming task.





This key can be used before running a function, or to choose "ALL" in a multiple selection.



This is your "end" key. Pressing it one or more times will move you back to the start of the mode, or all the way back to the standby message.

SOME CONVENTIONS:

All programming procedures assume that you are starting with the standby message showing in the display. If not, just press  until you get there.

Each programming procedure is highlighted by a pointing hand:  so it will stand out.

Definitions and helpful information will appear in shadow boxes:

HELPFUL HINT

When you see the word **CONTINUE** at the end of a function, it means to press

 until you return to the standby message.

CONTROL PANEL SWITCH FUNCTIONS EXPLAINED



Press this button to put your machine into the Price Setting mode. You can see maximum and minimum machine prices, and change prices for entire machine, product, or individual selection.



Press this button to set up how the Free Vend mode will operate.



Press this button to view the water tank temperature, software version number, machine and accessory configuration, and active selection status.



Press this button to:

- Select display language
- Select coin mechanism and options
- Select bill validator and options
- Select card reader and options
- Select monetary options
- Set winner feature
- Set mug discount option



Press this button to:

- View total sales and vends by whole machine, selection, or drink size
- Clear resettable data
- View or set machine ID



Press this button to:

- Download data into your portable data collection device (PDCD), **OR**
- Set printer baud rate, depending upon which device you are using



Press this button to:

- Set machine configuration
- Set which selections are active
- Set up water tank low power
- Set up blended selections
- Set up cup sizes
- Select SureVend™ options



Press this button to:

- Set time of day
- Set day, month, year
- Set up time of day intervals for inhibit, freevend, and discount vending
- Select display messages
- Edit messages
- Set message scrolling speed



Press this button to pay one or more coins from the coin mechanism.



Press this button to see any fault or condition that may place the machine out of service



Press this button to:

- Perform TEST VENDS
- Test machine functions
- Test displays
- Fill the water tank



Press this button to:

- Enter the SUPERVISOR mode
- Change the SUPERVISOR access code
- Lock and unlock access to functions
- Set free vend code

SUREVEND™

SureVend™ ensures that a cup is always available in the cup station before any money is collected or product delivered. The sensing system is a beam of infra-red light across the cup station which is broken by the cup when it falls into position.

The SureVend™ software monitors the cup station sensor during the time the cup ring is cycled and for three seconds afterward. If a cup is not detected, the software will first determine if a second cup ring with the same size cups exists and will then try to drop a cup from the second ring. If the second ring also fails to drop a cup or is not usable, the software will repeat the attempt from the first cup ring to attempt to clear any jams in the cup delivery area. Each ring will be tried up to two times. If a cup is still not detected by the infrared sensor then several things happen:

- Any ring that failed twice in a row is placed temporarily out-of-service for a length of time that is determined by the user,
- The customer's credit is either restored for another vend attempt or is returned automatically,
- Three beeps are sounded and the message *SELECT ANOTHER SIZE* is flashed if another size cup ring is available, or the message *INSERT MUG* is flashed in the event that no other cups are available. The customer may always get his money back by pressing the coin return button.

NOTE

INSERT MUG is the default message. You may customize this message if desired

(see "Edit Custom Message", **PAGE 49** for more information).

Special rules exist to protect both the customer and the operator from loss. First and foremost, the customer is protected because no drink is spoiled nor money lost because a cup fails to fall to the cup station. The customer is given every chance to get his original choice of cup size by trying at least twice per ring to eject a cup. If two rings are available with the same cup size, the system will alternately try to vend a cup from each ring until the cup is delivered or both rings are placed out-of-service.

The operator is protected by the anti-jackpot program of the system. It is conceivable that a customer could prevent cups from reaching the sensing area of the cup station in order to steal the cups and then get his or her money back for the vend. Under the SureVend™ Anti-Jackpot system, the operator can lose no more than two cups in a row per ring. Then that ring is temporarily placed out-of-service both to protect the customer and to discourage theft. The amount of time that the cup ring is out-of-service is programmable from 0 to 99 minutes. After the time has elapsed, the cup ring will return to service but the count of the two failures is kept. If the previous problem was theft, then the next vend attempt from that ring will be successful and the count of the two previous failures will be erased. If the problem is an actual system failure, then the third failure will permanently place that cup ring out of service until a service technician visits the machine.

Alternate cup vends and mug vends still work as before. If a cup ring is out of service due to SureVend™ the alternate vend will only be from a selected large cup to a small cup at the small cup price. An induced SureVend™ failure cannot cause an alternate vend from a selected small cup to a large cup at the small cup price. This protects the operator from customers trying to get large cup drinks at a small cup price. (SureVend™ will not automatically switch to a different cup size in mid-vend because it cannot be ensured that correct change will be returned for the new price.)

SureVend™ can be turned off if desired (see "Turn SureVend™ On or Off", **PAGE 42**).

THE SUPERVISOR MODE

The supervisor is allowed to do things that a normal user cannot, like controlling access to certain modes. The supervisor can lock out any of the programming modes to anyone who does not have the right "key". Once a supervisor enters the proper code, he or she will be able to:

- Change the supervisor access code
- Lock out any or all of the service keypad modes
- Set whether data is cleared with  or after being downloaded into a portable data collection device
- Grant or deny access to data items during **DATA RECALL**
- Modify the machine configuration

PROGRAMMING PROCEDURES



GAIN ACCESS TO THE SUPERVISOR MODE

1. Press . The display shows: *ENTER CODE*. You must enter the four-digit supervisor code within 6 seconds to gain access.

NOTE

A new machine has a factory-set supervisor code of **0000**.

When you have entered the right code, you will hear two beeps and see *UNLOCKED* in the display.



ENTER A NEW SUPERVISOR CODE

1. Follow the steps in "Gain Access To The Supervisor Mode", **PAGE 7**.
2. Press . The display shows *SUPER XXXX*. The X's represent the current supervisor code. Use the number keys to enter a new code.



IMPORTANT

If you enter a new code, be sure to keep a written record of it. There is no other way to access the SUPERVISOR mode.

3. CONTINUE.
-



ENTER A FREEVEND CODE



1. Follow the steps in "Gain Access To The Supervisor Mode", **PAGE 7**.
2. Press , then  until the display shows *FREE XXXX*. The X's represent the current freevend code. Use the number keys to enter a new code. If the code is anything other than "0000", it must be entered after the key lock is turned in order to enable free vends.
3. CONTINUE.



ENTER A NEW DATA RECALL CODE

If the proper non-zero code is entered, sales and non-resettable sales data can be viewed without opening the machine's door.

1. Follow the steps in "Gain Access To The Supervisor Mode", **PAGE 7**.

2. Press , then  until the display shows *NR XXXX*. The X's represent the currently entered code. Use the number keys to enter a new code, if desired.

NOTE

A code of *0000* disables this feature.

USAGE



With the machine in ready mode, enter the 4-digit code. When the correct code is entered, the non-resettable sales total is displayed. This display will remain active for 9 seconds, or until another key is pressed.

3. CONTINUE.







LOCK OR UNLOCK MODE OR PAYOUT KEYS

1. Follow the steps in "Gain Access To The Supervisor Mode", **PAGE 7**

2. Press , then  until the display shows either # *LOCKED* or # *UNLOCKED*. To see if a key is locked or unlocked, press that key.

3. Press  to change between locked and unlocked. When anyone other than the supervisor tries to enter a locked mode, the display shows *LOCKED*.

EXAMPLES: Press , then press  to lock the function. Now, non-supervisory users can NOT view any sales data.

If you want non-supervisory users to view data but not be able to clear data, leave the  key unlocked, but do lock .

NOTE

The following mode keys cannot be locked out:



4. CONTINUE.



SET PRINTER OR DEX OPTIONS

1. Follow the steps in "Gain Access To The Supervisor Mode", PAGE 7.

2. Press , then  until the display shows:

PRINTER - means that data will be sent directly to a printer,

- OR -

DEX ONLY means that data remains in memory after it is downloaded into a portable data collection device (PDCD),

- OR -

DEX+CLR means that resettable data is cleared after it is downloaded into a PDCD.

- OR -

NR DEX - a special DEX option. All sales data will become non-resettable.

Consult your DEX supplier before choosing this option.

3. Press  to change between the three choices.

4. CONTINUE.



SELECT PRINTER BAUD RATE (PRINTER MODE ONLY)

BAUD RATE The speed of data transfer, expressed in bits per second. Your printer can receive data at a certain rate, and you must tell the machine what that rate is.

1. Press . One of the following is displayed:

BAUD 1200 BAUD 2400 BAUD 4800 BAUD 9600



2. Press  until the correct baud rate for your printer is displayed.

3. CONTINUE.



SET DEX OPTIONS (DEX MODE ONLY)

1. Follow the steps in "Gain Access To The Supervisor Mode", PAGE 7.

2. Press , then  until the display shows one of two resettable bill validator totals transmitted to the DEX device:

CA 304 : N.C. - the value of bills in the stacker will be transmitted in a cash format. For example: 200 for two dollars. (This is the default setting.)

CA 304 : N.O. - the value of bills in the stacker will be transmitted in a dollar count format. For example: 2 for two dollars.

3. Press  to switch between the two choices. Consult your DEX handheld supplier for the proper settings for your machine.

NOTE

If your bill count is incorrect, the CA304 setting may be wrong. Try using the other setting.

4. Press  until the display shows one of the following two date/time options:

LAST.VND.ON - the DEX device will transmit the date and time of the last vend for each selection.

- OR -



LAST.VND.OFF - the DEX device will **NOT** transmit the date and time of the last vend for each selection. (This is the default setting)

5. Press  to switch between the two choices.

6. CONTINUE.



SET TALKER MODE

1. Follow the steps in "Gain Access To The Supervisor Mode", **PAGE 7**.
2. Press  , then  until the display shows *TALK ON* or *TALK OFF*.
3. Press  to turn the talker option ON or OFF.



NOTE

Talker hardware must be installed for this to work.

4. CONTINUE.





SELECT DISPLAY LANGUAGE

1. Press  . The current **LANGUAGE** displays. Press  to choose the desired language. Your choices are: *ENGLISH, DEUTSCH, FRANCAIS, ESPANOL, PORTUGUES, SWEDISH, NEDERLANDS, or FINNISH.*
2. CONTINUE.



SELECT COIN MECHANISM

1. Press  , then press  until the current **COIN MECHANISM** is shown in the display. Press  to choose the desired coin mechanism.
Your choices are: *DUMB MECH, MOB MECH, EXEC MECH, OR NO MECH*
2. Proceed to **SELECT MONETARY OPTIONS**, page 15, to customize your coin mechanism choice.

NOTE

Depending upon your choice of coin mechanisms, some choices may not display.

3. CONTINUE.



SELECT BILL VALIDATOR

1. Press , then press until one of the following is displayed:

- NO DBV* - No bills will be accepted or there is no bill validator installed (you can exit the function).
- PULSEDBV* - The pulse bill validator will accept \$1 bills.
- SER.1.2.5.10.20* - The serial bill validator is selected and will accept \$1, \$2, \$5, \$10, and \$20 bills. Use BILL SELECTION METHOD below to change the bills that will be accepted.
- MDB.1.2.5.10.20* - A standard MDB bill validator is selected. It will accept \$1, \$2, \$5, \$10 and \$20 bills. Use BILL SELECTION METHOD below to change the bills that will be accepted.

BILL SELECTION METHOD:

The standard \$1, \$2, \$5, \$10 and \$20 bills are enabled by pressing the **1, 2, 5, 6, or 7** key(s), respectively, to display which bill(s) will be accepted.

- MDB. <*>* - An MDB bill validator that accepts coupons or non-standard bills (normally used for non-U.S. currency) is connected and operating. Press to enter list of bills.

See BILL LIST OPERATION. See INITIAL SETUP OF NON-STANDARD BILL VALIDATOR.

- 2. Press to choose the desired option.
- 3. Proceed to "Select Monetary Options", **PAGE 15**, to customize your bill validator choice.

NOTE

Depending upon your choice of bill validator, some choices may not display.

- 4. CONTINUE.





INITIAL SETUP OF A NON-STANDARD BILL VALIDATOR



1. Connect the bill validator, and follow the steps in "Select Bill Validator", PAGE 13 to select *MDB.1.2.5.10.20* in the bill validator selection screens. *MDB. <*>* will not be an option yet. Exit the bill validator setup by press-

ing . Bill information is now collected from the validator.

2. Press , then press  until *MDB. <*>* displays.

3. Press . *1. 1.00 ON* will display. The first number (*1.*) indicates bill validator channel 1, the *1.00* is the bill denomination, and *ON* indicates that the validator will accept \$1.00 bills.

4. Press  to toggle the bill acceptance *ON* or *OFF*.

5. Press  and  to scroll through the list of other denominations and  to set them to *ON* or *OFF*.



6. Press  to move up to the top level screen.

NOTE

If a denomination does not display in the scroll list of available denominations, check the binary switch settings for the validator. If the binary switch for a given denomination is set to "off", it will not display in the list of denominations.



SELECT CARD READER

1. Press  , then press  until the current card reader is shown in the display. Press  to choose the desired card reader.
2. Your choices are: *NO CARD*, *DUMB CARD*, or *MOB CARD*.
3. Proceed to **SELECT MONETARY OPTIONS**, page 15, to customize your card reader choice.

NOTE

Depending upon your choice of card reader, some displays may not appear.

4. CONTINUE.





SELECT MONETARY OPTIONS

Certain options can be selected, depending upon which monetary devices you have selected.

This function lets you:

- Set change returning criteria
- Set declining balance
- Set currency acceptance on low change
- Set overbuy options
- Set last bill stacking options
- Set card reader revalue options

1. Press  , then press  until the display shows *CHANGE X.XX*.

X.XX represents the largest denomination coin or bill that will be changed without a purchase. Any non-zero value here will return all escrowed coins. (Each coin denomination for which the coin mech has a tube is called an **ESCROWED** coin because it can be returned.) When the coin return button is pressed, all coins inserted will be returned provided there is a coin mech tube for each of those coins, **EXCEPT** in the forced vend mode.

Some examples:

- CHANGE 0.00* - Forced vend; NO change returned without a purchase.
- CHANGE .25* - Returns change without purchase if all accepted coins are less than .25 denomination or have a payout tube. Acceptance of a dollar coin will not cause a Force Vend if the coin mechanism has a dollar coin payout tube. Otherwise, accepting a dollar coin or accepting and stacking of a dollar bill will cause a Force Vend.
- CHANGE 1.00* - Bills and non-escrowed coins less than or equal to \$1.00 will be changed without purchase. All escrowed coins are returned.

2. Press  until one of the following is displayed:
3. *ACC <\$\$ X.XX* -Accept any bill of value \$X.XX or less, regardless of available change. Hold the last bill which meets or exceeds maximum price in escrow. (This setting is normally used.)

- OR -

4. *ACC.STK X.XX* -Accept any bill of value \$X.XX or less, regardless of available change. Immediately stack the last bill.
Example: If setting is *ACC.STK 1.00* and maximum price is \$1.50. This setting will immediately stack the second \$1.00 bill inserted.

5. Press  to display the desired choice.

6. The value of "X.XX" has two purposes:
 - a. The value of "X.XX" tells the machine how big a bill or coin to accept even though there is not enough change in the coin mech to cover all possible paybacks.
For example, enter 1.00. Therefore, the machine will take a dollar bill or coin even though there is less than \$1.00's worth of change. Entering 5.00 tells the machine to take a five even though there is less than \$5.00's worth of change, and so forth.

NOTE

This could cause a customer to be short-changed.

Entering **0.00** means that bills or coins not held in escrow or in a tube will only be accepted if there is enough change to cover them.

- b. The value of "X.XX" tells the machine how much the customer is allowed to overbuy a product. The customer will be short-changed when an overbuy occurs. **Example:**
For a value of \$0.25: if there is no change in the machine and the customer inserts a \$1.00 bill. The customer can purchase a product for \$0.75 even though the change cannot be paid back. The customer will be short-changed. Normally a purchase will not be approved unless all change can be paid.
Entering **0.00** means that the vend will only be approved when the correct change can be returned (overbuy disabled).

7. Press  until the display shows: *LOW.MSG X.XX*. The display will show *USE EXACT CHANGE* when the amount of available change in the coin mechanism falls below the value of "X.XX". Enter a value with the number keys. For example, if *LOW.MSG 1.00* is displayed, the *USE EXACT CHANGE* message is displayed when less than a dollar's worth of change is in the coin mechanism.

DECLINING BALANCE: Once credit is established, multiple vends may occur until the coin return is pressed.

8. Press  until one of the following is displayed:
DECLINE.ON - More than one vend is allowed, with a declining balance.
 - OR -
DECLINE.OFF - A declining balance is not allowed.

9. Press  to display the desired choice.

10. Press  until one of the following is displayed (only for machines with Card option):
REVALUE.ON - Allows credit to be transferred onto the card
REVALUE.OFF - Credit cannot be transferred to the card

11. Press  to display the desired choice.



SET UP WINNER MODE

WINNER At preselected intervals, a customer may receive a refund for a selection. You can select the interval and qualifying selections.

1. Press [4 MACHINE CONFIG], then press [DOWN] until one of the following is displayed: WINNER OFF - Winner function is disabled.

- OR -

WIN XXX - Winners are allowed at certain intervals, represented by "XXX".

Press [EDIT] to display the desired choice.

If you selected WINNER OFF, you can exit the function.

2. The display shows WIN XXX. XXX represents the number of vends that must occur per each winner vend. For example, an interval number of 50 means that a winner can happen any one time during the next 50 vends. Using the number keys, enter an interval number between 10 and 9999.

3. Press [DOWN]. The display shows *- - - - - . The dashes in the display represent which selections are allowed winners. Press the appropriate letter key to enable a selection, press the key again to disable it. For example, pressing A, C, and E will cause the display to look like this: A - C - E - - - - meaning that all A, C, and E products can have a winner.

ADVANCED OPTIONS:

- Press [* TEST START] to enable all selections.
• Press [# CODE CLEAR] to deactivate all selections.
• Press 0 or 1 to set winner selections by cup size.

NOTE

If displaying WINNER by selection, press  once to redisplay wildcard (*, ABC....) selections.

AN EXAMPLE . . .

You want to enable winners on all selections except E and F. Do the following:

- a. Press . The letters *A* through *J* appear in the display instead of the dashes.
- b. Press "E" and "F". The letters *E* and *F* in the display are replaced by dashes.

NOTE

This is a two-part screen. Press  to display selections
X . . 2

4. CONTINUE.



SET UP MUG DISCOUNT

You can establish a discount for customers who use their own mug.

- 1. Press , then press  until the display shows *MUG DSC .00*.

This example shows the existing discount amount is zero.

- 2. Enter a discount amount. This will be in cents, for example press  or **5** to enter a discount amount of 5 cents.



3. CONTINUE.



SET THE MACHINE TYPE AND CONFIGURATION CODE (SUPERVISOR MODE ONLY)

1. Press , then until the display shows *MACH.TYPE 0* or *1*.
2. Press or 1 to enter *MACH.TYPE 1*.
3. Press until the display shows *0+J+ WXYZ*. “D” is the automatic delivery door status. A plus sign (+) means the door is on; a dash (-) means the door is off. Toggle this setting by pressing . “J” is the whipper setting. Toggle a plus sign (+) or a dash (-) with the **J** key. See "Whipper Options", **PAGE 26** for more information. "WXYZ" is the machine configuration code. W represents the machine type, X is the 6th product configuration, Y is the brewer configuration, and Z is canister mapping. The following tables give the possible values for each of the four numbers. Enter the appropriate configuration code for your machine.

Table D1 Machine Type Configuration

| Enter for (W) | Definition |
|---------------|-------------------------------------|
| 1 | Hot Drink Center model 675 |
| 5 | Hot Drink Center models 673 and 677 |

Table D2 6th Product (Selection C) Configuration

| Enter for (X) | Definition |
|---------------|---|
| 1 | No 6th product |
| 2 | 6th product present, but receives no condiments |
| 3 | 6th product present, may receive condiments |
| 4 | Water only |

SINGLE BREW

A machine with only one brewed selection (the second selection is freeze dried). Uses a single barrel brewer.

DUAL BREW

A machine with two brewed selections.

DUAL CONDIMENT

A machine with two separate sets of condiments (lightener/sugar) to avoid cross-flavoring.

Table D3 Brewer Configuration

| Enter for (Y) | Coffee Mix | Number of Brewers | Condiment Sets |
|---------------|-------------|-------------------|----------------|
| 1 | Single Brew | One | Single |
| 2 | Dual Brew | One | Single |
| 6 | Freeze Dry | None | Single |

Table D4 Canister Mapping (See figure below)

| Enter for (Z) | Menu Selection Letters for Canister Numbers | | |
|---------------|---|---|---|
| | 3 (Single condiment only) | 2 | 1 |
| 1 | F | B | A |
| 2 | F | A | B |
| 3 | B | F | A |
| 4 | B | A | F |

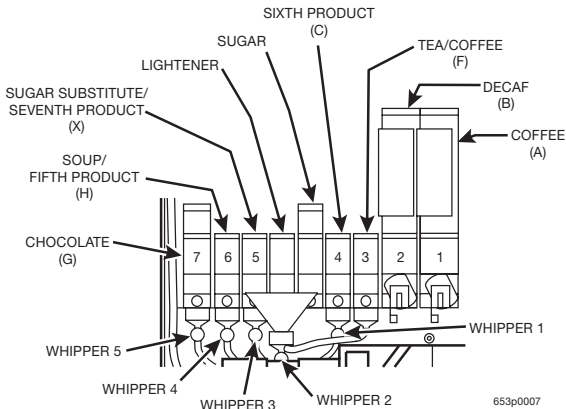

653p0007

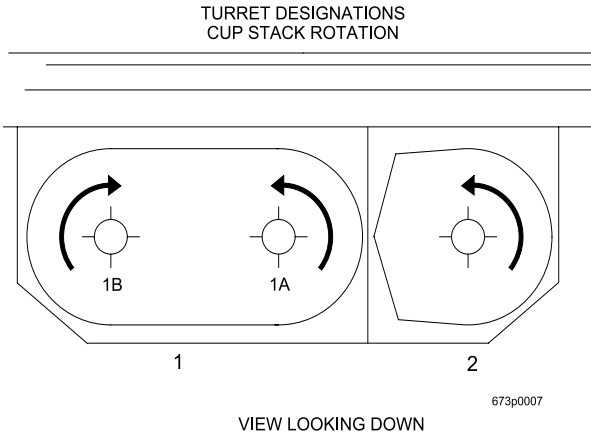

Canister Mapping



DISABLE SELECTIONS IN THE MERCHANDISER



- Press , then press  until the display shows something like this: *LK. ABCDEFGH*

This display means that all regular size selections (A - H) are not available for vending. An available selection has its letter replaced by a blank space.

Press  to display the second screen for X, Y, and Z selections.

- Press the appropriate letter to toggle the display on or off.

NOTE

Press  to lock all selections; press  to unlock all selections.



- CONTINUE.



SET UP CUP SIZES

Make sure the cup sizes you select agree with the cups you have actually loaded during setup.

1. Press  the display shows X 0Z 4 "X" is the currently selected drink size for the cups in turret 2 (normally large cups), "Y" is the currently selected drink size for the cups in turrets 1A and 1B (normally regular cups).

2. Press  to toggle through the #1 cup ring sizes; press  to toggle the #2 cup ring size.

3. Any changes made to the cup sizes must be "locked in". There are two ways to do this:

a. If you are keeping some cup sizes the same, or putting the cups in different cup rings, press and hold . The display momentarily shows CLEARING, two beeps sound, then shows FINISHED. This will reassign the old throw times to the new cup ring, if possible.

b. If you are loading all different size cups, or want to load all new default times, press and hold . The display momentarily shows CLEARING, two beeps sound, then shows FINISHED. This will reload the factory default times for all cup sizes, clearing any custom throw times you have established. (See the tables on the following pages for the factory default times.)

4. CONTINUE.



ASSIGN CUP SIZES TO SELECTIONS (SUPERVISOR MODE ONLY)

You can load up to two different sizes of cups in your machine (see "Set Up Cup Sizes", PAGE 23). You may not always want a certain selection to use all of the cup sizes in your machine. For example, espresso is normally served in regular cups, so you probably will not want it to be available in large or jumbo cups.

- 1. Press , then press until the display shows something like this: *0. ABCDEFGH*. This display means that the smaller of the two cup sizes (0) is available for all selections (A - H).

NOTE

Press to display all selections; press to clear all selections.

- 2. Press to display remaining selections (*0 X-2. . . .*). In this display, the "X" represents the 7th product, and the "2" represents the cup only selection.

NOTE

If you have only one cup size in your machine, you will not see the next display.

- 3. Press . The display shows something like this: *1. ABCDEFGH*. This display means that the larger of the two cup sizes (1) is available for all selections (A - H).
- 4. Press the appropriate letter to toggle the display on or off. A selection that doesn't vend the displayed size cup has its letter replaced by a dash (-).

NOTE

Press to display all selections; press to clear all selections.

- 5. Press to display remaining selections (*1 X-2. . . .*). In this display, the "X" represents the 7th product, and the "2" represents the cup only selection.

To vend a cup only, press 1, 2, 3 (large size) or 2, 3 (regular size).

- 6. CONTINUE.



SET UP A HOT DRINK

Be sure that the cup sizes you set in "Set Up Cup Sizes", PAGE 23, agree with the cup sizes actually in your machine. All procedures for setting up the hot drinks are similar, so this example will demonstrate how to set up the A selection, regular size fresh brew coffee.

1. Press , then press until the display shows *SETUP - **. The star (*) represents the selection (A, B, etc.). The dash (-) represents the size of the selection.
2. Press **A**. (If you were setting up the A selection for the large size drink, you would press **1** first, then **A**.) The display shows *WAT. A 8.25*. This means that the currently set water throw time for the A selection is 8.25 seconds. Enter a new time if desired.
3. Press . The display shows *DRY. A .60*. This means that the currently set dry product throw time for the A selection is .60 seconds. Enter a new time if desired.
4. Pressing after each display will cause the following screens to display:

- DRY. A+* View and change the settings for an extra strong drink
- SUG. A* View and change the settings for the sugar throw time
- SUG. A+* View and change the settings for extra sugar throw time
- LIT. A* View and change the settings for the lightener throw time
- LIT. A+* View and change the settings for extra lightener throw time
- SUB. A* View and change the settings for the sugar sub throw time
- SUB. A+* View and change the settings for extra sugar sub throw time
- STP. A* View and change the steep time
- STP. A+* View and change the steep time for an extra strong drink
- AIR. A* View and change the air compressor/pump running time
- DLY. A* View and change the amount of time after the vend to open the auto vend door

Whipper Options

WHP. A XXX Press  to view and change the whipper settings:

- ON- The last 3 seconds of the drink is always whipped
- ON+ The whole drink is always whipped
- OFF The drink is never whipped
- OPT See below

- If J+ is selected (see "Set the Machine Type and Configuration Code (Supervisor Mode Only)", PAGE 20):
 - OPT- The last 3 seconds of the drink is whipped *only* when the J key is pressed
 - OPT+ The whole drink is whipped *only* when the J key is pressed
- If J- is selected (see "Set the Machine Type and Configuration Code (Supervisor Mode Only)", PAGE 20):
 - OPT- The last 3 seconds of the drink is whipped *unless* the J key is pressed
 - OPT+ The whole drink is whipped *unless* the J key is pressed

DIFFERENCES:

Some selections will not show all of these items. The E selection will have some additional selections:

- WA.2 E View and set the water throw time for the cappuccino second product (chocolate)
- DR.2 E View and set the chocolate throw time for cappuccino
- PCT. E To automatically compute new times for cappuccino, enter a

percentage, then press . This percentage represents the amount of chocolate product in cappuccino, versus that in a normal chocolate drink. This time and the normal coffee settings will compute the new cappuccino time.

OPTIONS:

- a. At any of the preceding displays, you can press  to test throw that item.
- b. At any of the preceding displays, you can press * or # (on the selection switch panel) to step through a list of that item's throw times for other selections where that item is active. For example, pressing # at the *WAT. A* display will show the throw time for *WAT. B*. This is a handy way to move from one selection to another without going to the *SETUP* screen first.

NOTE

If you try to set up a selection that is not configured, the *SETUP* screen will remain in the display.

5. CONTINUE.



COLLECTING DRY PRODUCT GRAM THROWS

Measuring the gram throw allows you to get the right amount of dry product or condiment into your hot drink. To do this, you need a container to catch the product throw and an accurate gram scale to measure its weight.

1. Make a measuring container by cutting down a paper cup until it fits under the canister spout as shown.
2. Weigh the measuring cup and zero the gram scale accordingly.
3. Make 5 test throws as instructed in the programming steps.
4. Weigh each test throw, then add all 5 weights together and divide by 5 to get an average weight.
5. If necessary, adjust the throw time and repeat steps 3 and 4 until you get the correct product or condiment weight.

Tables D1 and D2 show the factory default settings for the various dry products sold by the merchandiser. They are good starting points to use in setting up your machine. In the end, the amount of dry product or condiments you use in your drinks depends upon taste and manufacturers' recommendations. Recommended weights and times are for guidance only, and you do not have to adhere to them.

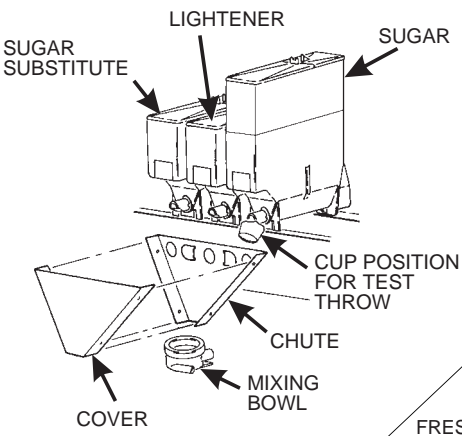

COLLECTING CONDIMENT THROWS

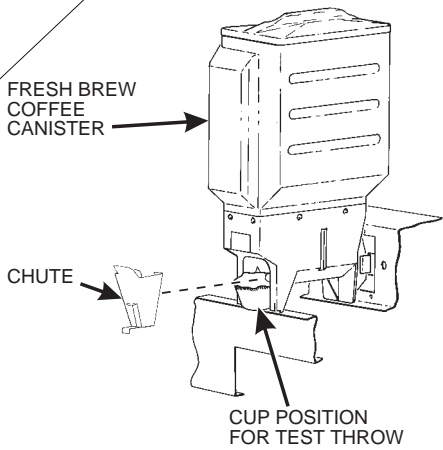

Table D1 Dry Product Weight and Throw Time Factory Default Settings

| Selection | | Weight (in grams) per size cup (in ounces) | | | | | | | | | |
|-----------|-------------------------------------|--|---------------|---------------|---------------|---------------|---------------|---------------|---------------|----------------|----------------|
| | | Throw times (in seconds) per size cup | | | | | | | | | |
| | | 5 | 7 | 8 | 9 | 10 | 12 | 14 | 16 | 18 | 20 |
| A | Fresh brew coffee | 5.70 1.60 | 8.00 2.20 | 9.00 2.50 | 10.00 2.80 | 11.00 3.10 | 13.00 3.65 | 15.30 4.25 | 17.50 4.85 | 19.60 5.45 | 21.80 6.05 |
| A | Freeze dry coffee | 0.90 0.35 | 1.20 0.50 | 1.50 0.60 | 1.60 0.65 | 1.80 0.70 | 2.20 0.90 | 2.55 1.00 | 2.90 1.15 | 3.25 1.30 | 3.65 1.45 |
| A | Strong freeze dry coffee | 1.10 0.65 | 1.50 0.90 | 1.80 1.10 | 2.00 1.20 | 2.20 1.35 | 2.60 1.60 | 3.05 1.60 | 3.50 2.15 | 3.95 2.40 | 4.35 2.70 |
| B | Fresh brew decaf | 5.70 1.60 | 8.00 2.20 | 9.00 2.50 | 10.00 2.80 | 11.00 3.10 | 13.00 3.65 | 15.30 4.25 | 17.50 4.85 | 19.60 5.45 | 21.80 6.05 |
| B | Freeze dry decaf | 0.90 0.35 | 1.20 0.50 | 1.50 0.60 | 1.60 0.65 | 1.80 0.70 | 2.20 0.90 | 2.55 1.00 | 2.90 1.15 | 3.25 1.30 | 3.65 1.45 |
| B | Strong freeze dry decaf | 1.10 0.65 | 1.50 0.90 | 1.80 1.10 | 2.00 1.20 | 2.20 1.35 | 2.60 1.60 | 3.05 1.60 | 3.50 2.15 | 3.95 2.40 | 4.35 2.70 |
| C | Soluble product | 10.8 2.45 | 15.0 3.35 | 17.8 4.00 | 19.4 4.35 | 21.6 4.85 | 25.9 5.80 | 30.20 6.80 | 34.50 7.75 | 38.85 8.75 | 43.15 9.70 |
| D | Fresh brew coffee ESPRESSO | 5.70 1.60 | 8.00 2.20 | 9.00 2.50 | 10.00 2.80 | 11.00 3.10 | 13.00 3.65 | 15.30 4.25 | 17.50 4.85 | 19.60 5.45 | 21.80 6.05 |
| D | Freeze dry coffee ESPRESSO | 0.90 0.35 | 1.20 0.50 | 1.50 0.60 | 1.60 0.65 | 1.80 0.70 | 2.20 0.90 | 2.55 1.00 | 2.90 1.15 | 3.25 1.30 | 3.65 1.45 |
| D | Strong freeze dry coffee ESPRESSO | 1.05 0.65 | 1.50 0.90 | 1.80 1.10 | 2.00 1.20 | 2.20 1.35 | 2.60 1.60 | 3.05 1.60 | 3.50 2.15 | 3.95 2.40 | 4.35 2.70 |
| E | Fresh brew coffee CAPPUCCINO | 5.70 1.60 | 8.00 2.20 | 9.00 2.50 | 10.00 2.80 | 11.00 3.10 | 13.00 3.65 | 15.30 4.25 | 17.50 4.85 | 19.60 5.45 | 21.80 6.05 |
| E | Freeze dry coffee CAPPUCCINO | 0.90 0.35 | 1.20 0.50 | 1.50 0.60 | 1.60 0.65 | 1.80 0.70 | 2.20 0.90 | 2.55 1.00 | 2.90 1.15 | 3.25 1.30 | 3.65 1.45 |
| E | Strong freeze dry coffee CAPPUCCINO | 1.05 0.65 | 1.50 0.90 | 1.80 1.10 | 2.00 1.20 | 2.20 1.35 | 2.60 1.60 | 3.05 1.60 | 3.50 2.15 | 3.95 2.40 | 4.35 2.70 |
| F | Instant tea | 0.90 0.70 | 1.20 1.00 | 1.50 1.25 | 1.60 1.30 | 1.80 1.60 | 2.20 1.85 | 2.55 2.10 | 2.90 2.40 | 3.30 2.20 | 3.65 2.05 |
| F | Strong instant tea | 1.10 0.90 | 1.50 1.25 | 1.80 1.60 | 2.00 1.75 | 2.20 1.85 | 2.60 2.10 | 3.05 2.10 | 3.50 2.15 | 3.95 2.40 | 4.35 2.70 |
| G | Chocolate | 17.00 2.80 | 24.00 4.00 | 28.00 4.65 | 31.00 5.15 | 34.00 5.65 | 41.00 6.80 | 47.50 7.90 | 54.50 9.00 | 61.00 11.80 | 68.00 12.25 |
| H | Soup | 4.30 0.70 | 6.00 1.00 | 7.00 1.15 | 7.60 1.25 | 8.50 1.35 | 10.20 1.65 | 11.90 1.95 | 13.60 2.25 | 15.30 2.50 | 17.00 2.80 |
| H | Soluble product | 10.80 2.45 | 15.00 3.35 | 17.80 4.00 | 19.40 4.35 | 21.60 4.85 | 25.90 5.80 | 30.20 6.80 | 34.50 7.75 | 38.85 8.75 | 43.15 9.70 |
| X | Soluble product | 10.80 2.45 | 15.00 3.35 | 17.80 4.00 | 19.40 4.35 | 21.60 4.85 | 25.90 5.80 | 30.20 6.80 | 34.50 7.75 | 38.85 8.75 | 43.15 9.70 |
| D | Sugar used in espresso | 2.20 0.35 | 2.85 0.45 | 3.50 0.55 | 3.80 0.60 | 4.15 0.65 | 5.10 0.80 | 6.05 0.95 | 6.70 1.05 | 7.65 1.20 | 8.50 1.35 |
| D | Extra sugar used in espresso | 3.20 0.50 | 4.15 0.65 | 4.80 0.75 | 5.10 0.80 | 5.76 0.90 | 6.70 1.05 | 8.00 1.25 | 9.30 1.45 | 10.55 1.65 | 11.50 1.80 |

Table D1 Dry Product Weight and Throw Time Factory Default Settings

| Selection | | Weight (in grams) per size cup (in ounces) | | | | | | | | | |
|-----------|------------------------------------|--|--------------|--------------|--------------|---------------|---------------|---------------|---------------|---------------|---------------|
| | | Throw times (in seconds) per size cup | | | | | | | | | |
| | | 5 | 7 | 8 | 9 | 10 | 12 | 14 | 16 | 18 | 20 |
| E | Sugar used in cappuccino | 3.60 0.45 | 5.20 0.65 | 6.00 0.75 | 6.55 0.80 | 7.30 0.90 | 8.70 1.10 | 10.20 1.25 | 11.60 1.45 | 13.10 1.65 | 14.55 1.80 |
| E | Extra sugar used in cappuccino | 4.60 0.60 | 6.95 0.90 | 7.75 1.00 | 8.50 1.10 | 9.25 1.20 | 11.15 1.45 | 13.10 1.70 | 15.00 1.95 | 16.95 2.20 | 18.50 2.40 |
| F | Sugar used in tea | 4.20 0.55 | 6.00 0.75 | 7.00 0.90 | 7.75 1.00 | 8.55 1.10 | 10.10 1.30 | 12.05 1.55 | 13.60 1.75 | 15.15 1.95 | 17.10 2.20 |
| F | Extra sugar used in tea | 5.45 0.70 | 7.75 1.00 | 8.95 1.15 | 9.70 1.25 | 10.90 1.40 | 12.85 1.65 | 13.60 1.75 | 17.50 2.25 | 19.45 2.50 | 21.75 2.80 |
| F | Lightener used in tea | 1.20 0.70 | 1.50 0.85 | 2.00 1.15 | 2.20 1.25 | 2.45 1.40 | 2.95 1.70 | 3.40 1.95 | 3.90 2.25 | 4.35 2.50 | 4.85 2.80 |
| F | Extra lightener used in tea | 1.55 0.90 | 2.15 1.25 | 2.50 1.45 | 2.75 1.60 | 3.00 1.75 | 3.60 2.10 | 4.20 2.45 | 4.80 2.80 | 5.45 3.15 | 6.05 3.50 |
| F | Sugar substitute used in tea | 0.60 0.75 | 0.85 1.05 | 1.00 1.25 | 1.10 1.35 | 1.30 1.60 | 1.50 1.90 | 1.70 2.10 | 1.90 2.40 | 2.20 2.75 | 2.40 3.00 |
| F | Extra sugar substitute used in tea | 0.80 1.00 | 1.10 1.35 | 1.30 1.60 | 1.40 1.75 | 1.60 2.00 | 1.90 2.40 | 2.15 2.70 | 2.50 3.10 | 2.80 3.50 | 3.10 3.90 |
| * | Sugar | 4.25 0.55 | 5.05 0.75 | 7.00 0.90 | 7.75 1.00 | 8.95 1.15 | 10.90 1.40 | 12.05 1.55 | 13.60 1.75 | 15.15 1.95 | 17.10 2.20 |
| * | Extra sugar | 5.45 0.70 | 7.75 1.00 | 8.95 1.15 | 9.70 1.25 | 10.90 1.40 | 12.85 1.65 | 13.60 1.75 | 17.50 2.25 | 19.45 2.50 | 21.75 2.80 |
| * | Lightener | 1.20 0.70 | 1.50 0.85 | 2.00 1.15 | 2.20 1.25 | 2.45 1.40 | 2.95 1.70 | 3.40 1.95 | 3.90 2.25 | 4.35 2.50 | 4.85 2.80 |
| * | Extra lightener | 1.55 0.90 | 2.15 1.25 | 2.50 1.45 | 2.75 1.60 | 3.00 1.75 | 3.60 2.10 | 4.20 2.45 | 4.80 2.80 | 5.45 3.15 | 6.05 3.50 |
| * | Sugar substitute | 0.60 0.75 | 0.85 1.05 | 1.00 1.25 | 1.10 1.35 | 1.30 1.60 | 1.50 1.90 | 1.70 2.10 | 1.90 2.40 | 2.20 2.75 | 2.40 3.00 |
| * | Extra sugar substitute | 0.80 1.00 | 1.10 1.35 | 1.30 1.60 | 1.40 1.75 | 1.60 2.00 | 1.90 2.40 | 2.15 2.70 | 2.50 3.10 | 2.80 3.50 | 3.10 3.90 |

D = Espresso

I = Chocolate times for cappuccino

E = Cappuccino

* The actual gram weight of a product or condiment throw will vary depending upon the type of product or condiment used. The weights given are approximate based on factory testing.

* Separate sugar, lightener, and sugar substitute timers are available for selections A/B/C/D, E, and F.



COLLECTING HOT WATER THROWS

National Vendors recommends the factory default times be used for hot water throws to ensure proper mixing. Table W1 gives the factory default water throw times for the various size cups and product selections.

WARNING
This water is *HOT!* Be careful.

For a non-brewed selection, collect the water throws as follows:

1. Place a cup in the cup delivery station.
2. Ensure the merchandiser is using the factory defaults for the cup sizes (see **SET UP CUP SIZES**, page 23).
3. Initiate the water throw for a selection.
4. Remove the cup and pour the water into a graduated cylinder.
5. Refer to table W1 for the correct volume of water.
6. Adjust the throw time for that selection (see "Set Up A Hot Drink", **PAGE 25**) and repeat steps 3 through 5 until the correct volume of water is thrown.
7. If you are unable to get the desired amount of water, reset the throw time to the factory default, then adjust the water valves. You may then readjust the throw times to fine-tune your water throws.

For a brewed selection, collect the water throws as follows:

1. Remove water supply hose from the brewer as shown on the next page.
2. Place the end of the hose in a graduated cylinder.
3. Initiate the water throw for a selection.
4. Remove the cup and pour the water into a graduated cylinder.
5. Refer to table W1 for the correct volume of water.
6. Adjust the throw time for that selection (see "Set Up A Hot Drink", **PAGE 25**) and repeat steps 3 through 5 until the correct volume of water is thrown.
7. If you are unable to get the desired amount of water, reset the throw time to the factory default, then adjust the water valves. You may then readjust the throw times to fine-tune your water throws.
8. Replace the water supply hose on the brewer.

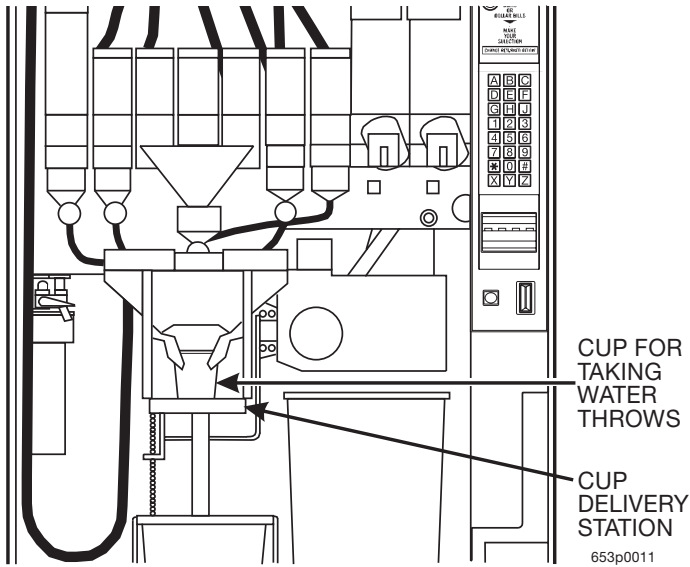

Table W1 Water Throw Default Times and Volumes

| Selection | Time (in seconds) per size cup | | | | | | | | | |
|---------------------|--------------------------------|--------------|-------------|---------------|---------------|--------------|--------------|--------------|--------------|--------------|
| | Volume (in ml) per size cup | | | | | | | | | |
| | 5 oz | 7 oz | 8 oz | 9 oz | 10 oz | 12 oz | 14 oz | 16 oz | 18 oz | 20 oz |
| A Fresh brew coffee | 5.00 135 | 7.00 190 | 8.25 220 | 9.00 240 | 10.00 265 | 12.00 320 | 14.00 375 | 16.00 425 | 18.00 480 | 20.00 535 |
| B Fresh brew decaf | 5.00 135 | 7.00 190 | 8.25 220 | 9.00 240 | 10.00 265 | 12.00 320 | 14.00 375 | 16.00 425 | 18.00 480 | 20.00 535 |
| A Freeze dry coffee | 5.00 125 | 7.00 175 | 8.25 210 | 9.00 225 | 10.00 255 | 12.00 305 | 14.00 355 | 16.00 405 | 18.00 455 | 20.00 505 |
| B Freeze dry decaf | 5.00 125 | 7.00 175 | 8.25 210 | 9.00 225 | 10.00 255 | 12.00 305 | 14.00 355 | 16.00 405 | 18.00 455 | 20.00 505 |
| C 6th Product | 5.00 110 | 7.00 155 | 8.25 185 | 9.00 200 | 10.00 225 | 12.00 270 | 14.00 315 | 16.00 360 | 18.00 405 | 20.00 450 |
| D Espresso (FB) | 2.25 62.5 | 3.50 87.5 | 4.15 110 | 4.50 120 | 5.00 133 | 6.00 160 | 7.00 185 | 8.00 210 | 9.00 225 | 10.00 265 |
| D Espresso (FD) | 2.50 62.5 | 3.50 87.5 | 4.15 105 | 4.50 112.5 | 5.00 127.5 | 6.00 153 | 7.00 175 | 8.00 205 | 9.00 225 | 10.00 255 |
| F Tea | 5.00 125 | 7.00 175 | 8.25 210 | 9.00 225 | 10.00 255 | 12.00 305 | 14.00 355 | 16.00 405 | 18.00 370 | 20.00 505 |
| G Chocolate | 5.00 105 | 7.00 145 | 8.25 170 | 9.00 185 | 10.00 205 | 12.00 245 | 14.00 290 | 16.00 330 | 18.00 370 | 20.00 410 |
| H Soup | 5.00 115 | 7.00 165 | 8.25 195 | 9.00 210 | 10.00 235 | 12.00 285 | 14.00 330 | 16.00 380 | 18.00 425 | 20.00 475 |
| H Soluble Product | 5.00 110 | 7.00 155 | 8.25 185 | 9.00 200 | 10.00 225 | 12.00 270 | 14.00 315 | 16.00 360 | 18.00 405 | 20.00 450 |
| X Soluble Product | 5.00 110 | 7.00 155 | 8.25 185 | 9.00 200 | 10.00 225 | 12.00 270 | 14.00 315 | 16.00 360 | 18.00 405 | 20.00 450 |

RECIPES

CAPPUCCINO

Cappuccino is made with various ratios of chocolate to coffee, according to taste. Lightener (E timer) is also used for cappuccino. For an example, the default chocolate-to-coffee ratio of 15/85 in a 8.25 oz. cup consists of the following:

- A chocolate throw (DR.2) lasting .65 seconds, providing 15% of the normal chocolate throw (approximately 5.4 grams*).
- A water throw for the chocolate (WA.2) lasting 2.65 seconds (chocolate product throw plus 2 seconds to ensure the mixing bowl is fully rinsed). The volume is about 59 ml, depending upon how the flow rate is adjusted.
- A throw for cappuccino coffee (product E) equal to a normal coffee (product A) throw.
- A water throw for the freeze dry coffee selection (water E) lasting for 5.55 seconds (132 ml).

- OR -

- A water throw for the fresh brew coffee selection (water E) lasting for 5.55 seconds (153 ml). **In either case the water volume is enough to fill the remainder of the cup.**

The actual mixing sequence is as follows:

1. The coffee portion of cappuccino is made using the same canister/valve combination as the normal (A) coffee.
2. After the coffee is completely in the cup, the chocolate portion is made with the selection G canister/valve combination. This gives the drink its traditional "layering".

Chocolate weights will vary with different products

HINTS:

To “fine tune” your Cappuccino drink to your exact taste, set a ratio close to what you like (between 5% and 50%). Adjust the individual timers using  and



until you are satisfied. You may find it necessary to cut down on the amount of sweetener available to a cappuccino drink with a high ratio of chocolate, as the chocolate contains sweetener of its own.

CAFFÉ LATTE

Caffé Latte has a rich, robust coffee flavor. It is a full-bodied hot beverage with extra creamer, whipped to frothy perfection, with sugar optional. Try this recipe to expand your gourmet product selections and increase premium pricing opportunities.

ENTER THE SUPERVISOR CODE:

1. Press . The display shows: *ENTER CODE*. You must enter the four-digit supervisor code within 6 seconds to gain access.

NOTE



A new machine has a factory-set supervisor code of **0000**.

When you have entered the right code, you will hear two beeps and see *UNLOCKED* in the display.

SET THE MACHINE TO VEND A LARGE "D" SELECTION:

NOTE

Ensure that your machine has been configured for two separate cup sizes, and that the larger size is 12 oz. See **SET UP CUP SIZES**, page 23.

1. Press the following keys: , then  until the display shows *1. ABCDEFGH*. Make sure the "D" is displayed. If not, press "D" on the selection switch panel to display the "D".
2. Press  twice to return to the standby message.

SET UP YOUR SELECTION:

**1 D 6 or 7 Drink Selection Setup
Large Cup Size**

| | 12 OZ | | 14 OZ | | 16 OZ | | 18 OZ | | 20 OZ | |
|---------------|-----------|-------------|-----------|--------------|-----------|-------------|-----------|--------------|-----------|--------------|
| | TIME SEC. | FB / FD | TIME SEC. | FB / FD | TIME SEC. | FB / FD | TIME SEC. | FB / FD | TIME SEC. | FB / FD |
| WATER | 12 cup | 320/305 ml | 14 cup | 375/355 ml | 16 cup | 425/405 ml | 18 cup | 480/455 ml | 20 cup | 535/505 ml |
| COFFEE | 3.65 | 13.0/2.2 gm | 4.25 | 15.3/2.55 gm | 4.85 | 17.5/2.9 gm | 5.45 | 19.6/3.25 gm | 6.05 | 21.8/3.65 gm |
| SUGAR | 0.35 | 2.7 gm | 0.40 | 3.1 gm | 0.45 | 3.5 gm | 0.55 | 4.25 gm | 0.60 | 4.65 gm |
| EX SUGAR | 0.35 | 2.7 gm | 0.40 | 3.1 gm | 0.45 | 3.5 gm | 0.55 | 4.25 gm | 0.60 | 4.65 gm |
| LIGHT-ENER | 2.90 | 5 gm | 3.35 | 5.85 gm | 3.85 | 6.7 gm | 4.35 | 7.55 gm | 4.85 | 8.45 gm |
| EX LIGHT-ENER | 2.90 | 5 gm | 3.35 | 5.85 gm | 3.85 | 6.7 gm | 4.35 | 7.55 gm | 4.85 | 8.45 gm |
| STEEP TIME | 12.5 | | 12.5 | | 12.5 | | 12.5 | | 12.5 | |
| STEEP + TIME | 12.5 | | 12.5 | | 12.5 | | 12.5 | | 12.5 | |
| WHIP | ON + | | ON + | | ON + | | ON + | | ON + | |

To get these measurements, see "Collecting Dry Product Gram Throws", **PAGE 28**, and perform test throws of the dry ingredients. See "Collecting Hot Water Throws", **PAGE 31**, and perform test water throws.

EUROPEAN CAPPUCCINO

Introducing a great new blended drink called EUROPEAN CAPPUCCINO: First, a portion of cappuccino topping mix (or lightener) is dispensed, then layered on top is a small serving of strong coffee.



- 1. Replace product in the soup (or international coffee) canister with the lighter or cappuccino topping mix.
- 2. Press . The display shows: ENTER CODE. You must enter the four-digit supervisor code within 6 seconds to gain access.

NOTE

A new machine has a factory-set supervisor code of 0000.

When you have entered the right code, you will hear two beeps and see

UNLOCKED in the display. Press .

- 3. Reconfigure the machine:
 - a. Press , then press  until the display shows 0- J+ WXYZ.
 - b. WXYZ is the current configuration code, where W = the machine type, X = 6th product configuration, Y = brewer configuration, and Z = canister mapping. See "Set the Machine Type and Configuration Code (Supervisor Mode Only)" on page 20. You will be changing the number represented by X. The only way to do that is to change all four numbers, so at this time write down your configuration code so you will know where to start if you make a mistake.
 - c. Replace "X" as follows:

| If your current value of X is: | Change it to: |
|--------------------------------|---------------|
| 1 | 5 |
| 2 | 6 |
| 3 | 7 |
| 4 | 8 |



For example: If your current configuration code is W 2 Y Z, you will enter the numbers W 6 Y Z. Your new drink will be selected with the H key. Valid selections are H3 (black) and H4 (with sugar). After the reconfiguration, timers for the topping mix or lightener are under the H selection as DR.2, and the timers for the coffee serving are under the H selection. Now, you need to alter the water throw times for the two selections. Consult Table W1 on page 32 for suggestions for a starting point for your new drink.

BLENDDED SELECTIONS

Two new blended selections are offered with the Y and Z keys. Any two base products, a primary and secondary, can be blended from 15% to 85% in 5% increments. The primary product is dispensed first followed by the secondary creating a 'layer.' To reverse the order dispensed to the cup, invert the primary and secondary products. The blended drink will support condiments if condiments are valid for either of the base products.



Blended selections are configured in the BLEND list item of the PRODUCT CONFIG list. The Y and Z keys select the blended selections from the BLEND list. Once the Y or Z key is pressed, you can select the blend selections and the percentage. The arrow keys toggle between the selection and percentage list items and the 1 and 2 keys edit the primary and secondary products, respectively.

For example to set up the Y blended selection:

1. Press  then press  until the screen displays BLEND - *.
2. Press Y; the screen now displays Y1.# Y2.#. # represents the primary/secondary products currently selected.
3. Repeatedly press 1 until your selected primary product appears next to Y1. (NOTE: the selected secondary product will not be included in the available primary products list.)
4. Repeatedly press 2 until your selected secondary product appears next to Y2. (NOTE: the selected primary product will not be included in the available secondary products list.)
5. Press . The screen displays Y1 ** Y2 **. ** represents the percentage of the primary and secondary products selected.
6. Press 1 to increase the primary product percentage, or press 2 to increase the secondary product percentage. (NOTE: the alternate product percentage value is automatically changed to total 100%).



VIEW OR SET THE HOT WATER TANK TEMPERATURE

1. Press  then  until the display shows *SET202°F*. In this example, 202° is the water tank temperature setpoint in degrees Fahrenheit. If a decimal point appears next to the "F", the heater is on.
2. If desired, enter a new setpoint in the accepted range of 149° - 205° F (65° - 96° C).



NOTE

The lower limit for vending is 20° below setpoint, up to a maximum of 180° F (82° C).

3. To change display units (replace the "F" with a "C" for Celsius), press .
4. CONTINUE.



SET UP LOW TEMPERATURE DISPENSING



1. Press  then press  until the screen displays either
 - a. *LTDIS OFF*. This causes the machine to operate the same as the previous Hot Drink Center. For example, with a setpoint temperature of 202° F the machine will inhibit vending when the water tank temperature falls below 182° F.
 - OR -
 - b. *LTDIS ON*. Allows vending to a water tank temperature of 140° F.
2. Press  to change between *ON* and *OFF*.
3. CONTINUE.





SET UP LOW POWER SETTINGS

Low power settings allow for the water tank to be set to a lower temperature at up to 4 different dates and times.

For example, you want to lower the tank temperature to 160° F overnight on Mondays through Fridays. The machine tank temperature setpoint will be changed to 160° F at 6:00 pm and maintained at that temperature until 5:00 am on the following morning when the setpoint is returned to 202° F. Please keep in mind that at 5:00, the machine will just *begin* to increase to the 202° F setpoint temperature. It is up to you to determine how long that will take and to allow enough time for the tank to be at its proper temperature when the machine will be used. Typically, one hour is adequate to return to the normal operating temperature. NOTE: The machine *OUT OF SERVICE* condition during the low power interval will be determined by how you have set the *LTDIS* configuration.

1. Press  then press  until the screen displays *LOW.PWR.-----*.



Press the number of the time interval you want to edit, or  to edit time interval 1 (we will use interval 1 for this example).

2. The display shows *LOW.PW ON* or *LOW.PW OFF*. This display tells you whether your time interval (represented by 1) is on or off. Press  to change the condition of the time interval.
3. If you turn an interval ON, it must be edited. You can edit a time interval now, then turn it OFF until another time.

4. Press . The display shows *1.STRT X.XX. X.XX* is the currently set start time. Enter a new start time (24-hour format) for this interval. To enter the time for 6:00 pm, enter 1800.

5. Press . The display shows *1.STOP X.XX. X.XX* is the currently set stop time. Enter a new stop time (24-hour format) for this interval. To enter the time for 5:00 am, enter 0500.



6. Press . The display shows *1.@ - - - - -*. The dashes represent the days that this time interval is active. Pressing number keys 1 through 7 switches the days on/off. 1=sunday, 2=monday, etc. For example, press "2", "3", "4", "5", and "6". The display now shows *1.@ - M T W T F -*. This interval is active on Monday through Friday.

7. Press . The display shows 1. *MESG OFF* or 1. *MESG X*. "OFF" means there is no custom message selected, and "X" represents the custom message number set for this interval. Press the number key of the message (1 through 8) you want displayed. To edit this message, press  and follow the procedure given in **EDIT CUSTOM MESSAGE** (page 49). Press **0** to turn the message OFF for this time interval.
8. Press . The display shows *L.PWR 202*.
9. Press **1**, **6**, and **0**. The screen displays *L.PWR 160*.
10. CONTINUE.



SET THE AUTOMATIC BREWER RINSE TIME (BREWER EQUIPPED MACHINES ONLY)

The brewer will be automatically rinsed by one of two methods: You can specify a set time of day when the brewer is rinsed, or you can specify that rinsing takes place a set time after the last brewed selection is vended.

1. Press  then  until the display shows one of the following:
SAN.TIM 4.5 The time of day (in hours and tenths of hours) the machine rinses the brewer. In this example, brewer rinse takes place each day at 4:30 am. Range: 0.0 - 23.9 in .1 hour (6 minute) increments.
- OR -
SAN.HRS 2.5. In this example, brewer rinse takes place 2.5 hours after the last vend. Range: 2.0 - 12.5 hours, in .1 hour (6 minute) increments.

NOTE



If 24 hours passes without a vend, no rinsing will take place. This eliminates unnecessary rinsing over a weekend or holiday.

2. Whichever one of the two choices is displayed is the method by which the brewer will be rinsed. Press  to switch between these two displays. Enter a new time, if desired.
3. CONTINUE.



SET THE BOWL RINSE TIME

Mixing bowl(s) can be automatically rinsed by one of two methods: You can specify a set time of day when the bowl is rinsed, or you can specify that rinsing takes place a set time after the last selection is vended.

1. Press  then  until the display shows one of the following:

RIN.HRS 2.5 - This is how soon the machine rinses the bowls after a vend. In this example, bowl rinse takes place 2.5 hours after the last vend. Range: 2.0 - 12.5 hours, in .1 hour (6 minute) increments.

- OR -

RIN.TIME 4.5 - The time of day (in hours and tenths of hours) the machine rinses the bowls. In this example, bowl rinse takes place at 4:30 am. Range: 0.0 - 23.9 in .1 hour (6 minute) increments.

NOTE

If 24 hours passes without a vend, no rinsing will take place. This eliminates unnecessary rinsing over a weekend or holiday.



- OR -

RINSE OFF - No bowl rinse takes place.

2. Press  to switch between these options, and the number keys to enter new values.
3. CONTINUE.



TURN SUREVEND™ ON OR OFF

1. Press  then  until the display shows one of the following:



SURE.V OFF: None of the SureVend™ functions are available. Use this if the SureVend™ system is not installed, or there is some reason you do not want to use it (for example in a high cup theft situation).

SURE.V ON. The SureVend™ system is operative. All of the SureVend™ functions are available.

2. Press  to switch between the two choices.
3. CONTINUE.



OPTIONAL OR MANDATORY SUREVEND™

1. Press  then  until the display shows one of the following:

OPT'N SURE.V: The machine reverts to home switch operation of the ring motors if the SureVend™ system cannot operate normally because of an obstruction in the cup station or for any other reason.

MUST SURE.V: The vending machine is operational only if the SureVend™ system is determined to be working. Otherwise, the machine will go temporarily out of service until the blockage or other error is corrected.

2. Press  to switch between the two choices.
3. CONTINUE.



SET UP THE SUREVEND™ ANTI-JACKPOT TIMER

1. Press then until the display shows *AJP.TMR XXM. XX*
 represents how many minutes SureVend™ will be disabled for either cup ring. The same value applies to the two timers (one on each ring).
2. Enter a number using either keypad.

If any cup ring motor fails to deliver a cup on two consecutive attempts, the cup ring goes out of service. After the time set in step 2 has elapsed, the cup ring goes back in service and is given one more chance to deliver a cup. If cup delivery is again unsuccessful, the ring goes out of service until the machine is serviced. A successful delivery on any cup ring will reset the failed attempts for that particular cup ring. If both cup rings perform three consecutive failed attempts (and the SureVend™ sensor is determined to be working), the entire machine goes in the "mug only" mode until the machine is serviced. If either cup ring performs three consecutive failed attempts with the other cup ring in anti-jackpot timer mode, the entire machine will be in "mug only" mode (assuming SureVend is working) until the preset time elapses (one more attempt will be made to deliver a cup) or the machine is serviced by a route operator.

NOTE

A setting of *00* will disable this feature. A setting of *99* will disable the ring until the next service call.

CONDITIONS:

If the cup sizes are the same, the machine alternates ring motor cycles until either a cup is detected or both rings reach two consecutive failed attempts. If the cup sizes are different, the selected ring is cycled up to two times before returning credit. If the customer selects a large size drink and that ring is out of service, the customer gets a small drink (if in service) and receives change.



VIEW SOFTWARE VERSION

1. Press , and press until the display shows *VER XXXXXX*.
 "XXXXXX" represents the current software version number.
2. CONTINUE.



SET THE TIME OF DAY

1. Press . The display shows *TIME HH.MM*. "HH.MM" is the time of day in 24-hour format.
2. Enter the current time using the number keys.



NOTE

9:00 am is entered with a leading zero, like this: 0900; 9:00 pm is entered as 2100.

3. CONTINUE.



SET MONTH, DATE, AND YEAR

1. Press , and press  until the display shows *MM/DD/YY X*. "MM" is the month, "DD" is the date, YY is the year, X is the day of the week (1=sunday, 2=monday, etc.)

2. Enter the current month, date, and year using the number keys.
For example, press the following keys to enter February 15, 2002:
0, 2, 1, 5, 0, 2

Once a date is entered, the day of the week will automatically adjust to the correct day.

3. Press  to switch between MM/DD and DD/MM formats
4. CONTINUE.



SET DAYLIGHT SAVINGS OPTION

1. Press , then press  until the display shows something like:
DST N.AMER

2. Press  to select the appropriate option for your machine. The options are:



DST N.AMER (North America), *DST UK/EUR.*, *DST AUSLIA*, *DST OFF.*

3. CONTINUE.





SET TIME-OF-DAY INHIBIT VENDING

Vending can be inhibited up to four times a day.

1. Press , then press  until the display shows *INHIB* - - - -.
2. See "Time Interval Editing", **PAGE 46** for an example of how to set up time-of-day inhibited vending.





SET TIME-OF-DAY FREE VENDING

1. Press , then press  until the display shows *FREEV* - - - -.
2. See "Time Interval Editing", **PAGE 46** for an example of how to set up time-of-day free vending.



SET TIME-OF-DAY DISCOUNT VENDING

1. Press , then press  until the display shows *DISCT* - - - -.
2. See "Time Interval Editing", **PAGE 46** for an example of how to set up time-of-day discount vending.



TIME INTERVAL EDITING

You can select up to four times of day for each special vending period.



NOTE

If two or more of these time periods overlap, the interval with the highest priority will overrule the other(s). This order of precedence is:

- 1. INHIBIT
- 2. FREEVEND
- 3. DISCOUNT



For example, if a DISCOUNT time period is scheduled for a certain area before the end of an INHIBIT time period, DISCOUNT does not begin until the INHIBIT interval has ended for that area.

The time interval editing procedure is almost the same for the INHIBIT, FREEVEND, and DISCOUNT intervals. There is one difference (Step 3 below) for the DISCOUNT time interval, so we will use it in our example. Assume you just finished the "Set Time-of-Day Discount Vending", PAGE 45 procedure. Step 1 picks up where you left off . . .

- 1. The display shows *DISCT - - - -*. Press the number of the time interval you want to edit, or  to edit time interval 1 (we'll use interval 1 for this example).
- 2. The display shows *1.DISCT ON* or *1.DISCT OFF*. This display tells you whether your time interval (represented by 1) is on or off. Press  to change the condition of the time interval.

NOTE



If you turn an interval ON, it must be edited. You can edit a time interval now, then turn it OFF until another time.



- 3. Press . The display shows *1.DSCT X*. "X" represents the discount percentage for this period. Enter a discount percentage of 25 with the number keys. (Discount percentages of from 0 to 99 are permitted.) The machine will apply a 25% discount to each price, rounding up to the nearest nickel (or whatever is the smallest coin accepted by the coin mechanism).
- 4. Press . The display shows *1.STRT X.XX*. X.XX is the currently set start time. Enter a new start time (24-hour format) for this interval. To enter the time for 3:30 pm, enter 1530.

5. Press . The display shows *1.STOP X.XX*. X.XX is the currently set stop time. Enter a new stop time (24-hour format) for this interval. To enter the time for 6:00 pm, enter 1800. You have now established a 25% discount that starts at 3:30 pm and ends at 6:00 pm.

6. Press . The display shows *1.@ - - - - -*. The dashes represent the days that this time interval is active. Pressing number keys 1 through 7 switches the days on/off. For example, press "2", "4", and "6". The display now shows *1.@ - M-W-F-*. This discount interval is only active on Monday, Wednesday, and Friday.

7. Press . The display shows ** - - - - -*. The dashes represent the products affected by this time interval. Press the appropriate letter key to enable a product, press the key again to disable it. For example, pressing A, C, and E will cause the display to look like this: *A - C - E - - - -*, meaning that all A, C, and E selections are affected by this interval.

Press  to turn on all levels; press  to turn all levels off.

8. Press . The display shows *1. MESSG OFF* or *1. MESSG X*. "OFF" means there is no custom message selected, and "X" represents the custom message number set for this interval. Press the number key of the message (1 through 8) you want displayed. To edit this message, press  and follow the procedure given in **EDIT CUSTOM MESSAGE**, page 49. Press **0** to turn the message OFF for this time interval.

9. CONTINUE.

STANDBY MESSAGE The message that is displayed during normal vending periods when there are no out-of-service faults on the machine.



SELECT A STANDBY MESSAGE

1. Press , then press  until the display shows *STANDBY XX*.

"XX" represents the current message number selected for the standby message. Two dashes mean that the factory-set message is selected.

2. To select a message, just press the corresponding number (1 through 8). To display the factory-set message, press 0.
3. The selected message (except the factory-set message) can be edited. To do this, press  and follow the procedure given in **EDIT CUSTOM MESSAGE**, page 49.
4. CONTINUE.



SELECT AN OUT-OF-SERVICE MESSAGE



1. Press , then press  until the display shows *SERVICE XX*.

"XX" represents the current message number selected to display when the machine is out-of-service. Two dashes mean that the factory-set message is selected.

2. To select a message, just press the corresponding number (1 through 8). To display the factory-set message, press 0.
3. The selected message (except the factory-set message) can be edited. To do this, press  and follow the procedure given in **EDIT CUSTOM MESSAGE**, page 49.
4. CONTINUE.



SELECT A FREEVEND MESSAGE



1. Press , then press  until the display shows *FREE XX*. "XX"

represents the current message number selected for the message that displays when the machine is in the freevend mode. Two dashes mean that the factory-set message is selected.

2. To select a message, just press the corresponding number (1 through 8). To display the factory-set message, press 0.
3. The selected message (except the factory-set message) can be edited. To do this, press  and follow the procedure given in **EDIT CUSTOM MESSAGE**, page 49
4. CONTINUE.







EDIT CUSTOM MESSAGE

- 1. Press , then press  until the display shows *EDITMSG'S*. Press the number of the message you want to edit. *MESSAGEX* is displayed (X represents the message number you pressed).

NOTE

Custom message 8 represents the *INSERT MUG* message.

- 2. Press . The message text is displayed with the first character flashing.
- 3. To view the message, press . The message scrolls across the display. To stop the scrolling, press .
- 4. When the character you want to change is flashing, either enter it directly, or use  and  to step through the character set until the desired character is displayed. Use the arrow keys to highlight different characters. See the section on the next page for an explanation of special keys and the character set.

SHORTCUT

Instead of stepping through the whole character set to enter a letter that is not on your keypad, enter one close to the one you want,

then step to it. Example: If you want to enter an **L**, first press ,

then press  six times. Your **L** should now be displayed.

THE END OF MESSAGE CHARACTER

This is the most important character in your message, because it tells the machine when the message is ended. If you don't use this character, your message will be followed by a bunch of zeros. This character can be selected either from the character set or by a direct key entry (see "ENTERING YOUR MESSAGE", PAGE 50).



ENTERING YOUR MESSAGE

Most of the keys on the control panel have a special purpose to help you create and edit your messages:



Inserts an **R** at the flashing character.



Inserts a space at the flashing character.



Inserts an **S** at the flashing character.



Deletes the current character and closes up the space.



Inserts a **T** at the flashing character.



Deletes the current character and leaves the space.



Repeats the letter to the left of the flashing character.



Enters the special "end of message" character, which denotes the end of the message.



"Pages" through the message, ten characters (one screen) at a time.



Steps forward and backward through the message, one character at a time.



Steps forward and backward through the character list, one character at a time.

| | | | | | |
|---|---|---|---------|---|---|
| 0 | A | J | U | (| |
| 1 | B | L | V |) | |
| 2 | C | M | W | □ | |
| 3 | D | N | X | P | |
| 4 | E | O | Y | + | |
| 5 | F | P | Z | □ |) |
| 6 | G | Q | (SPACE) | / | ? |
| 7 | H | R | - | . | □ |
| 8 | I | S | \$ | < | 0 |
| 9 | J | T | □ | = | ⊗ |





VIEW WATER TANK TEMPERATURE

1. Press . The display shows *XXX °F*. "XXX" is the current water tank temperature. "° F" means that the temperature is displayed in degrees Fahrenheit (may be shown in degrees Celsius, depending upon your choice. See "View or Set the Hot Water Tank Temperature", **PAGE 38**). A decimal point shown in the display indicates that the tank heater is operating.
2. CONTINUE.



VIEW MACHINE TYPE/CONFIGURATION SETTING

1. Press , then press  until display shows *MACH.TYPE*
then press  until the display shows *D- J- PORS. P, Q, R, and S* represent settings specific to your machine. See "SET THE MACHINE TYPE AND CONFIGURATION CODE (SUPERVISOR MODE ONLY)", **PAGE 20** for an explanation of this display.
2. CONTINUE.



VIEW CUP SIZES ASSIGNED TO SELECTIONS

1. Press , then press  until the display shows *C - - C - - - G -*.

This example shows that regular size cups are assigned to selections C & G.

NOTE

Press  to display the remaining selections: *C X - - - 2 - - -*

NOTE

If you have only one cup size in your machine, you will not see the next display.

2. Press . The display shows *1. ABC - - FGH*. This example shows that large size cups are assigned to selections A thru C and F thru H.

NOTE

Press  to display the remaining selections: *C X - - - 2 - - -*

3. CONTINUE.



PAYOUT COINS

1. Press . If a dumb mech was selected, the display shows *NDQ=123*; if an MDB mech was selected the display shows *PAY 123*.

2. Press . A dumb mech pays out one Nickel; an MDB mech pays a

coin from tube 1. Press . A dumb mech pays out one Dime; an

MDB mech pays a coin from tube 2. Press . A dumb mech pays out one Quarter; an MDB mech pays a coin from tube 3.

3. To continuously pay out coins, hold down the appropriate key.
4. CONTINUE.



SET PRICES

- Press . The display shows something like **** 2.50 .25**. This display shows the maximum and minimum prices set in the machine. In this example, the maximum price is \$2.50 and the minimum is \$0.25.
- Enter prices using one of the following methods:

SET ENTIRE MACHINE TO ONE PRICE ...

- Press . The display shows **** X.XX**. Enter a price using the number keys. All selections in the machine are now set to this price.

SET THE PRICE OF AN INDIVIDUAL SELECTION:

- Press the number and letter of the selection to be priced.
(for example: **1A**) The display shows **1A X.XX**. Enter a price using the number keys. The price for 1A (product A, large cup) is set.
- Press . The display shows **1B X.XX**. Enter a price for 1B (product B, large cup) using the number keys.
- Press to toggle through and set prices for each selection in turn.
You can also enter the number and letter for a specific selection (this avoids scrolling through the entire selection list).

- CONTINUE.



VIEW NONRESETTABLE SALES AND VEND DATA

- Press . The display shows **NR\$ XX.XX**. "XX.XX" is a dollar and cents figure showing the total of all sales in the machine. This is a running total, and is not resettable.
- Press . The display shows **NR X**. "X" is the total number of vends made by the machine. This is a running total, and is not resettable.
- CONTINUE.



VIEW DATA FOUR DIFFERENT WAYS

Paid sales and vends can be viewed four different ways:

1. ****\$ XX.XX** - Total Paid Sales for the machine
2. **1*\$ XX.XX** - Total Sales by Drink Size
3. ***H\$ XX.XX** - Total Sales by Selection (both sizes)
4. **1H\$ XX.XX** - Total Sales by Individual Selection.

See next four sections for details.



VIEW TOTAL PAID SALES



1. Press , then press  until the display shows ****\$ XX.XX**.

"XX.XX" is a dollar and cents figure showing the total of all PAID sales in the machine (as opposed to unpaid sales like winner and free vends). This is the total since the last time it was cleared.

2. CONTINUE.





VIEW TOTAL SALES BY DRINK SIZE

1. Press , then press  until the display shows ****\$ XX.XX**.
2. Press **C**. The display will read **C* XX.XX. XX.XX** is the total sales for the small cup size.
3. Press  to see the total sales of the larger cup size.
4. CONTINUE.







VIEW TOTAL SALES BY SELECTION (BOTH CUP SIZES)

1. Press , then press  until the display shows ****\$ XX.XX**.
2. Press **A**. The display will read ***A XX.XX**. **XX.XX** will be the total sales, for both the large cup and small cup for selection A,
3. Press  to cycle through all available selections.
4. CONTINUE.







VIEW TOTAL SALES BY INDIVIDUAL SELECTION

1. Press , then press  until the display shows ****\$ XX.XX**.
2. Press **U** and **A**. The display will read **UA XX.XX**. **XX.XX** will be the total sales, for selection A, small cup.
3. Press . The display will show **UB XX.XX**. Press  repeatedly to cycle through the total sales of each small cup selection. Continue pressing  to view the total sales of each large cup selection.
4. CONTINUE.





VIEW TOTAL PAID SALES BY PRICE LINE

1. Press , then press  until the display shows ****\$ XX.XX**.
2. Press . The display shows **.30'3430.50**. This is an example of a price line for items priced at \$0.30. The amount following the apostrophe ('), is the total dollar amount of the sales for this amount. In this example, there was total sales of \$3,430.50 for the \$0.30 item.
3. Press  repeatedly to view all price lines.
4. CONTINUE.







VIEW TOTAL PAID VENDS

1. Press , then press  until the display shows **** XX**. "XX" is the total number of paid vends for the entire machine.
2. If desired, view this data by individual selection or drink size.
3. CONTINUE.





VIEW TOTAL PAID VENDS BY PRICE LINE

1. Press , then press  until the display shows **** XX**.
2. Press . The display shows **.30'11435**. This is an example of a price line for items priced at \$0.30. The amount following the apostrophe ('), is the total number of sales for this amount. In this example, there was a total of 11,435 sales of the \$0.30 item.
3. Press  repeatedly to view all price lines.
4. CONTINUE.



CLEAR ALL RESETTABLE DATA

1. Press . The display shows **NR\$ XX.XX**. This is a running total, and is not resettable.
2. Press and hold . Two beeps sound and the display shows **CLEARING** momentarily, and then changes to **FINISHED**. All data is cleared.
3. CONTINUE.



CLEAR PAID SALES DATA ONLY

1. Press , then press  until the display shows ****\$ XX.XX**.

"XX.XX" is a dollar and cents figure showing the total of all PAID sales in the machine (as opposed to unpaid sales like winner and free vends). This is the total since the last time it was cleared.

2. Press and hold . Two beeps sound and the display shows *CLEARING* momentarily, and then changes to *FINISHED*. All paid sales data is cleared; other data is not cleared.
3. CONTINUE.



VIEW AMOUNT IN COIN BOX (NOT SHOWN IF ZERO)

1. Press , then press  until the display shows **CBX XX.XX**.

"XX.XX" is the dollar and cents amount in the coin box.

2. To clear the amount in the coin box, Press and hold . Two beeps sound and the display shows *CLEARING* momentarily, and then changes to *FINISHED*.





WARNING

To ensure the coin box total is accurate, make sure to clear the coin box total every time you empty it and do not clear this total unless you also empty the coin box.

3. CONTINUE.







VIEW AMOUNT IN VALIDATOR (NOT SHOWN IF ZERO)

1. Press , then press  until the display shows *DBV XX.XX*.
"XX.XX" is the dollar amount in the bill stacker.
2. Press  to show the quantities of bills in the stacker. For example, the display shows *\$0120*, meaning that there are 20 dollar bills in the bill stacker. Press  again to show the quantities of other bills, such as \$5s, \$10s, or \$20s.
3. CONTINUE.







VIEW FREEVEND SALES BY TIME INTERVAL (NOT SHOWN IF ZERO)

1. Press , then press  until the display shows *-0\$ XX.XX*.
2. Press , then press  until the display shows *1.FRV .00*. This is the total sales for freevend interval 1, shown even if zero.
3. Press  to view intervals 2 through 4.
4. CONTINUE.







VIEW DISCOUNT SALES BY TIME INTERVAL (NOT SHOWN IF ZERO)

1. Press , then press  until the display shows ****\$ XX.XX**.
2. Press . The display shows **1.DSC .00**. This is the total sales for discount interval 1.
3. Press  to view intervals 2 through 4.
4. CONTINUE.







VIEW FREE VENDS (NOT SHOWN IF ZERO)

1. Press , then press  until the display shows **-0\$ XX.XX**.
2. Press , then press  until the display shows **FRV XX.XX**.
"XX.XX" is the total machine-wide freevends, shown even if zero.
3. CONTINUE.



VIEW WINNERS (NOT SHOWN IF ZERO)

1. Press , then press  until the display shows **-0\$ XX.XX**.
2. Press , then press  until the display shows **WIN XX.XX**.
"XX.XX" is the total machine-wide winners, shown even if zero.
3. CONTINUE.





VIEW TIME DATA

1. Press , then press  until the display shows *TIME DATA*.

2. Press . Something similar to the following message scrolls across the display:

MAIN.1 237M 01/30 10.13

This example shows the latest time interval the main (machine) door was open (1). It was open for 237 minutes, and was opened on January 30 (01/30) at 10:13 am (10.13). Press . If applicable, similar displays will appear for intervals 2, 3, and 4. Otherwise, go to the next step.

3. Press . The following message scrolls across the display:

LAST POWER 01/30 13.51 FOR 00. 0.23

This example shows that the last time the machine lost power was on January 30 (01/30) at 1:51pm (13.51) for zero days, zero hours, and 23 minutes (00. 0.23).

4. Press . The following message scrolls across the display:

LONGS.T POWER 01/30 10.58 FOR 00. 2.47

This example shows that the longest time the machine was without power was on January 30 (01/30) at 10:58am (10.58) for zero days, 2 hours and 47 minutes (00. 2.47).

5. Press . The following message scrolls across the display:

FULL CLEAR 01/30 8.58

This example shows that the last time resettable sales was fully cleared was on January 30 (01/30) at 8:58am (8.58).

6. Press . The following message scrolls across the display:

TIME SET 01/30 9.15

This example shows that the last time the time or date was set was on January 30 (01/30) at 9:15 am (9.15).

7. Press . The following message scrolls across the display:

PRICE SET 01/30 9.42

This example shows that the last time prices were set was on January 30 (01/30) at 9:42 am (9.42).

8. Press . The following message scrolls across the display:

LAST.VND OR 01/29 4.51



This example shows that the last vend for selection 0A was on January 23 at 4:51 am.

Press  to scroll through the last vend times for each selection.

9. CONTINUE.





VIEW TOTAL UNPAID SALES (NOT SHOWN IF ZERO)

- Press , then press  until the display shows *.0\$ XX.XX*.
"XX.XX" is the total unpaid sales (free vends, winner vends, 100% discounts, zero price vends) for the entire machine.
- If desired, view this data by tray and individual selection.
- CONTINUE.





VIEW TOTAL UNPAID VENDS (NOT SHOWN IF ZERO)

- Press , then press  until the display shows *.0 XX*. "XX" is the total number of unpaid vends for the entire machine.
- If desired, view this data by tray and individual selection.
- CONTINUE.





**VIEW NUMBER OF TEST VENDS
(NOT SHOWN IF ZERO)**

1. Press , then press  until the display shows *TEST X*. "X" is the number of test vendes.
2. If desired, view this data by product and individual selection.
3. CONTINUE.





**VIEW NUMBER OF MUG VENDS
(NOT SHOWN IF ZERO)**

1. Press , then press  until the display shows *MUG X*. "X" is the number of mug vendes.
2. If desired, view this data by tray and individual selection.
3. CONTINUE.





**VIEW NUMBER OF ALT VENDS
(NOT SHOWN IF ZERO)**

An ALT VEND occurs when a smaller cup size is unavailable and the machine vendes the smaller selection by using a larger cup. The customer will get the larger cup, but receive the smaller volume of product (at the small cup price). To view the number of ALT VENDS,

1. Press , then press  or  until the display shows *ALT X*. The "X" is the number of larger cups used to fill smaller selections.
2. CONTINUE.





VIEW MACHINE ID NUMBER

1. Press , then press  or  until the display shows *ID. XXXXXX*. The X's represent the 6-digit machine ID number.
2. You can edit the machine ID number if the supervisor access code has been previously entered (see "Gain Access To The Supervisor Mode", **PAGE 7**).
3. CONTINUE.







VIEW CUP RING CYCLES RELATED TO SUREVEND™ (NOT SHOWN IF ZERO)

1. Press , then press  until the display shows *SV.TOT XX. XX*
represents the number of vends during which more than one ring cycle was required to successfully dispense a cup.
2. Press  to clear the count.
3. CONTINUE.





VIEW TIMES NO CUP WAS DETECTED AFTER A CUP RING CYCLED (NOT SHOWN IF ZERO)

1. Press , then press  until the display shows *SV.FL1 XX. XX*
represents the number of times a cup was not detected after ring 1 cycled. Check the cup ring adjustment (see the *Operator's Guide*), or the cup stack for damage if the count is excessive.
2. Press  to clear the count.
3. Press  until the display shows *SV.FL2 XX. XX* represents the number of times a cup was not detected after ring 2 cycled. Check the cup ring adjustment (see the *Operator's Guide*), or the cup stack for damage if the count is excessive.
4. CONTINUE.



VIEW HOME SWITCH USAGE RELATED TO SUREVEND™ (NOT SHOWN IF ZERO)

1. Press , then press  until the display shows *LWD.SV XX. XX*
represents the number of times home switches were used due to *OPT'N SURE.V* selected but not working.
2. CONTINUE.



TEST VEND SELECTIONS AND VERIFY CREDIT ADDED

1. Press . The display shows *TEST .00*. You may now test vend selections. If you insert money into the machine, the zeros in the display will be replaced with the amount of the credit. After the item vends, your money will be returned.



NOTES

SureVend™ is not operational during a test vend. You may make one more test vend if you close the door while still in TEST VEND mode.

2. CONTINUE.
-





TEST DROP A CUP

1. Press , then press  until the display shows *CUP TEST*.
 2. Press  to drop a cup.
 3. CONTINUE.
-





TEST THE AUTOMATIC DELIVERY DOOR

1. Press , then press  until the display shows *DOOR TEST*.
 2. Press . The automatic delivery door operates.
 3. CONTINUE.
-





TEST THE WHIPPER(S)

1. Press , then press  until the display shows *WHIP TEST*.
 2. Press the number key that corresponds to the whipper you want to test. It will run for one cycle.
 3. CONTINUE.
-





TEST THE GRINDER(S)

1. Press , then press  until the display shows *GRIND TEST*.
2. Press the number key that corresponds to the grinder you want to test. It will run for one cycle.
3. CONTINUE.



TEST THE AIR

1. Press , then press  until the display shows *AIR TEST*.
2. Press  to run the air compressor.
3. CONTINUE.



TEST THE BREWER

1. Press , then press  until the display shows *BREW TEST*.



NOTE

Keep away from the brewer mechanism while it is operating. Coming into contact with moving parts could injure you.

2. Press to test each brewer position:
BREW'R BREW=The brewer is in the BREW POSITION.
BREW'R HOME=The brewer is in the HOME position.
3. CONTINUE.





RINSE THE MIXING BOWLS

1. Press , then press  until the display shows *BOWL RINSE*.
2. Press  to rinse the mixing bowls. The display shows *RINSING* until the operation is complete.
3. CONTINUE.





RINSE THE BREWER

1. Press , then press  until the display shows *BREW RINSE*.
2. Press  to rinse the brewer. The display shows *RINSING* until the operation is complete.
3. CONTINUE.



TEST SWITCHES OR SENSORS

1. Press , then press  until the display shows *IN.MTKPHL 12*.
2. Actuate each switch or sensor to test its function:
M = mug/cup sensor (if equipped) K = freevend keyswitch
P = waste pail switch H = high water tank level switch
L = low water tank level switch 1 = ring 1 cup sensor switch
2 = ring 2 cup sensor switch

As you actuate each input, the display element representing that switch blinks on. Releasing the switch causes that element to blink off again.

3. CONTINUE.



VIEW SUREVEND™ LAST RECORDED CALIBRATION VALUE

1. Press  SureVend until the display shows *CAL.LST XXX*. XXX can be any number from 0 to 255, and represents the most recent value read from the sensor. The lower the number the greater the sensor blockage. A number of 255 means that there is a fatal problem with the SureVend™ interface board. Ensure the SureVend™ interface PCB is properly connected to the main controller PCB.
2. CONTINUE.



VIEW SUREVEND™ AVERAGE CALIBRATION VALUE



1. Press , then press  until the display shows *CALAVE XXX*.

XXX represents the average sensor calibration value (should be between 50 and 255 for proper sensor operation - i.e. 51 through 254). Although this number could go as low as 20, the SureVend™ system will be inoperative in this condition.

2. CONTINUE.



CLEAR TANK ERRORS AND FILL THE TANK

1. Press , then press  until the display shows *TANK FILL*.
2. Press . This clears any tank error and starts filling the tank, if necessary.

If it is taking a long time to fill the tank AND THERE ARE NO LEAKS, you may see *TANK ERR* in the diagnostic list again. Just press







again after making sure there are no other problems, such as a restriction in the water inlet line or a clogged water filter.

3. CONTINUE.



TEST THE DISPLAY

1. Press , then press  until the display shows *DSPLY TEST*. The "DRINK BEING SERVED" lamp is lighted (if so equipped), and remains lighted until you leave this function.
2. Press  to light all display segments; press  to turn them off.
3. Pressing a **NUMBER KEY** on the control panel causes all segments to display that character.
4. CONTINUE.



VIEW DIAGNOSTIC MESSAGES

1. Press . The display shows any of the following diagnostic messages, depending upon any fault(s) present:

| | |
|------------------|---|
| <i>NO ERRORS</i> | None of the following errors are detected: |
| <i>KEYPAD XY</i> | Key(s) x, y stuck. |
| <i>ROM ERROR</i> | Error in the programming EPROM. Machine will not operate. |
| <i>RAM ERROR</i> | RAM is not initialized or is not compatible with the currently loaded software. If this message appears, initialize your RAM by performing the following procedure: |

NOTE: Initializing RAM will erase all your data and drink settings. Be sure you have written this information down before continuing.

Press AND HOLD  until two beeps are heard, and the display shows *FINISHED*.

| | |
|---------------------|---|
| <i>LOCKS SET</i> | All selection keys are locked out. |
| <i>KEYSWITCH</i> | The keyswitch input is active and configured as an inhibit. |
| <i>MACH.TYPE 0</i> | Machine type error displays machine type screen. NOTE: This is the actual machine type screen. You may enter the correct machine type number directly on this screen without further action. |
| <i>D+J+WXYZ</i> | Configuration error; displays the machine configuration screen. NOTE: this is the actual config screen. You may enter the correct config number directly on this screen without further action. (Verify cup size and product times in the product configuration screen. |
| <i>TANK ERR</i> | Tank failed to fill or refill. |
| <i>RING 1, 2</i> | The cup ring is jammed. |
| <i>MTR 1A1B2X</i> | Cup turrets are jammed |
| <i>NO CUPS 1, 2</i> | Out of cups. |
| <i>BREWER JAM</i> | The brewer is jammed. |
| <i>WASTE PAIL</i> | The waste pail is full. |
| <i>LOW WATER</i> | The water level in the tank is low. |
| <i>COLD WATER</i> | Water in the tank is too cold to vend. |
| <i>NO SENSOR</i> | Temperature sensor failed or missing. |
| <i>NO FLOAT</i> | Float sensor failed or missing. |

| | |
|-----------------------|---|
| <i>WHIP 1 2 3 4 5</i> | Whipper motor failure (motor 1, 2, 3, 4, 5). |
| <i>DOOR JAM</i> | The automatic delivery door is jammed. |
| <i>NO MECH</i> | Coin mech not detected - machine will not operate if configured for coin mech. |
| <i>MECH COMM</i> | Incomplete coin mech communications — check harness. |
| <i>MECH.SENSOR</i> | Coin mech reporting a bad tube sensor — replace mech. |
| <i>MECH ROM</i> | Replace the coin mechanism. |
| <i>MECH.ERR</i> | There is a problem with the coin mech. |
| <i>MECH.ACCEPT</i> | Coin mechanism acceptor section is unplugged from the main body of the coin mech. Connect the cable and cycle machine power OFF and then ON. |
| <i>MECH JAM</i> | One or more coin tubes are jammed. Pay a coin from each tube until the jam is cleared. |
| <i>CARD.F.COMM</i> | Incomplete card reader communications (card reader is not operational). |
| <i>DEBIT CARD</i> | Card reader reporting error — machine will not operate if configured for DEBIT ONLY. |
| <i>CHECK DBV</i> | Bill validator reporting error — machine will not operate. Empty stacker, clear jams, etc. |
| <i>DBV.ACCEPT</i> | The merchandiser is telling the bill validator not to accept any bills. Check the enabled channels of the bill validator. |
| <i>DBV COMM</i> | Incomplete bill validator communications — check harness. |
| <i>DBV MOTOR</i> | One of the motors has failed. The unit will disable itself until the error is corrected. Check for bill stuck in the acceptance path. If no bill is present, replace the validator. Cycle machine power OFF and then ON. |
| <i>DBV SENSOR</i> | One of the sensors in the bill validator has failed. The unit will disable itself until the error is corrected. Check for bill stuck in the acceptance path. If no bill is present, replace the validator. Cycle machine power OFF and then ON. |
| <i>DBV JAM</i> | A bill is jammed in the acceptance path. The unit will disable itself until the error is corrected. Remove bill stuck in the acceptance path. Cycle machine power OFF and then ON. |
| <i>DBV STACKR</i> | The stacker is open or removed. The unit will disable itself until the error is corrected. Install the stacker correctly. |
| <i>CHK PRICE</i> | Price error detected and changed to maximum - check prices. |
| <i>NONE READY</i> | all selections are reported out of service. |
| <i>SV.ERR CUP 1</i> | Cup ring 1 is out of service due to a SureVend™ error. |
| <i>SV.ERR CUP 2</i> | Cup ring 2 is out of service due to a SureVend™ error. |

| | |
|--------------------|---|
| <i>SV.ERR PCB</i> | SureVend™ is ON but not working. The last calibration sample was 255. Check that the SureVend™ PCB is present at J34. |
| <i>SV.ERR SNSR</i> | SureVend™ is ON but not working. The last calibration sample was ≤50. Check for a blocked sensor or disconnected harness. |
| <i>AJP.TMR1 XX</i> | SureVend™ is active and ring 1 anti-jackpot timer is ON. XX is a value between 1 and 99 in minutes. |
| <i>AJP.TMR2 XX</i> | SureVend™ is active and ring 2 anti-jackpot timer is ON. XX is a value between 1 and 99 in minutes, and represents the amount of time left on the anti-jackpot timer for this cup ring. |
| <i>FLTR PAPER</i> | Brewer filter paper is empty. |
| <i>NO BREWER</i> | Brewer is missing or malfunctioning. |
| <i>BREWER.ERR</i> | The brewer is in an incorrect position. |
| <i>BREWER JAM</i> | The brewer has not reached an appropriate position within a certain timeout period. Check for a physical jam or a motor stall condition. |
| <i>RESET BRWR</i> | The brewer is clamped and not vending, or is not in a brewer test mode. Close the door (if open), or run a brew test. |



DOWNLOAD DATA TO A PDCD

1. Connect your portable data collection device (PDCD) in accordance with its operating instructions.
2. Press . Data is downloaded into your PDCD.

NOTE

Depending upon the setting selected in "Set Printer or DEX Options", **PAGE 10**, data may be cleared after the download is complete.

3. CONTINUE.



SET FREEVEND OPTIONS

- 1. Press , then press  until one of the following is displayed:

FREE OFF - Normal vending mode. No items are on freevend. (A closure on the optional keyswitch input causes the machine to go out of service.)

- OR -

FREE ON - All items are on freevend. The credit display shows *NO MONEY REQUIRED*

(A closure on the optional keyswitch causes the machine to go out of service.)

- OR -

FREE W/KEY - All items are freevended while there is a closure on the optional keyswitch input. Normal cash sales are supported when the optional keyswitch input is open.

- OR -

FREE ONCE - A closure on the optional keyswitch input causes only the next item to be freevended. Coin mechanism errors are ignored. This state is designed for card or token systems where one item is vended per token. Normal cash sales are also supported.

- 2. Press  until the option you want is displayed.

- 3. If you selected *FREE W/KEY*, press . The display shows **ABC-----*

This display represents the selections which may get free vends. Enable the selections by pressing the appropriate letter key.

- 4. CONTINUE.

Programming Procedure Index

A

| | |
|------------------------------------|----|
| Air, Test | 65 |
| Alt Vends, View | 62 |
| Anti-Jackpot Timer, SureVend | 43 |

B

| | |
|------------------------------|----|
| Baud Rate, Select | 10 |
| Bill Validator, Select | 13 |
| Bowl, Rinse Time | 41 |
| Bowls, Rinse | 65 |
| Brewer | |
| Rinse | 66 |
| Rinse Time | 40 |
| Test | 65 |

C

| | |
|-------------------------------------|----|
| Card Reader, Select | 15 |
| Clear | |
| All Resettable Data | 56 |
| Paid Sales Data Only | 57 |
| Tank Errors and Fill the Tank | 67 |
| Code | |
| Configuration | 20 |
| Data Recall | 8 |
| Freevend | 7 |
| Supervisor | 7 |
| Coin Box, View Amount | 57 |
| Coin Mechanism, Select | 12 |
| Coins, Payout | 52 |
| Configuration | |
| Code, Set | 20 |
| Setting, View | 51 |
| Cup Sizes | |
| Assign to Selections | 24 |
| Set Up | 23 |
| View | 52 |
| Cup, Test Drop | 64 |

Programming Procedure Index

D

| | |
|---|--------|
| Data | |
| Clear All Resettable | 56 |
| Clear Paid Sales Only | 57 |
| Download to a PDCD | 70 |
| Recall Code | 8 |
| View Four Different Ways | 54 |
| View Nonresettable Sales and Vend | 53 |
| View Time | 60 |
| Date, Set | 44 |
| Daylight Savings, Set | 44 |
| DEX, Options, Set | 10, 11 |
| Diagnostic Messages, View | 68 |
| Disable Selections | 22 |
| Discount | |
| Mug | 19 |
| Vending, Set | 45 |
| View Sales by Time Interval | 59 |
| Display Language, Select | 12 |
| Door, Delivery, Test | 64 |

E

| | |
|---------------------|----|
| Errors, Clear | 67 |
|---------------------|----|

F

| | |
|-----------------------------------|----|
| Free Vending, Set | 45 |
| Free Vends, View | 59 |
| Freevend | |
| Code, Enter | 7 |
| Message, Select | 48 |
| Set Options | 71 |
| View Sales by Time Interval | 58 |

G

| | |
|---------------------|----|
| Grinder, Test | 65 |
|---------------------|----|

H

| | |
|-------------------------|----|
| Hot Drink, Set Up | 25 |
|-------------------------|----|

I

| | |
|----------------------------|----|
| ID Number, View | 62 |
| Inhibit Vending, Set | 45 |

K

| | |
|----------------------------|---|
| Keys, Mode or Payout | 9 |
|----------------------------|---|

Programming Procedure Index

L

| | |
|---------------------------------------|----|
| Language, Select | 12 |
| Lock | |
| Mode Key | 9 |
| Payout Key | 9 |
| Low Power Settings, Set | 39 |
| Low Temperature Dispensing, Set | 38 |

M

| | |
|---------------------------------|----|
| Machine Type, Set | 20 |
| Message | |
| Edit Custom | 49 |
| Freevend, Select | 48 |
| Out-of-Service, Select | 48 |
| Standby, Select | 48 |
| Mode Keys, Lock Or Unlock | 9 |
| Monetary Options, Select | 15 |
| Month, Day, and Year, Set | 44 |
| Mug Discount, Set Up | 19 |

O

| | |
|--------------------------------------|----|
| Out-of-Service Message, Select | 48 |
|--------------------------------------|----|

P

| | |
|-----------------------------------|----|
| Payout Coins | 52 |
| Payout Keys, Lock Or Unlock | 9 |
| PDCD, Download Data | 70 |
| Prices, Set | 53 |
| Printer | |
| Baud Rate, Select | 10 |
| Options, Set | 10 |

R

| | |
|--------------------|----|
| Rinse | |
| Brewer | 66 |
| Mixing Bowls | 65 |
| Rinse Time | |
| Bowl, Set | 41 |
| Brewer, Set | 40 |

Programming Procedure Index

S

| | |
|--|----|
| Sales | |
| By Drink Size, View | 54 |
| By Individual Selection, View | 55 |
| By Selection, View | 55 |
| Discount, View by Time Interval | 59 |
| Freevend, View by Time Interval | 58 |
| Machine Total, View | 54 |
| Paid, View | 55 |
| Unpaid, View | 61 |
| Selections, Disable | 22 |
| Sensors, Test | 66 |
| Software Version, View | 43 |
| Standby Message, Select | 48 |
| Supervisor | |
| Code, Enter | 7 |
| Mode, Gain Access | 7 |
| SureVend | 63 |
| Anti-Jackpot Timer | 43 |
| Optional or Mandatory | 42 |
| turn on or off | 42 |
| View Average Calibration Value | 67 |
| View Last Recorded Calibration Value | 66 |
| Switches, Test | 66 |

T

| | |
|---|----|
| Talker Mode, Set | 12 |
| Tank | |
| Fill | 67 |
| Temperature, View or Set | 38 |
| Temperature | |
| View or Set Tank | 38 |
| View Water Tank | 51 |
| Test | |
| Air | 65 |
| Automatic Delivery Door | 64 |
| Brewer | 65 |
| Display | 67 |
| Drop a Cup | 64 |
| Grinder | 65 |
| Switches or Sensors | 66 |
| Vend Selections and Verify Credit Added | 64 |

Programming Procedure Index

T

| | |
|-----------------------------|----|
| Test | |
| Whipper | 64 |
| Throws | |
| Dry Product Gram | 28 |
| Hot Water | 31 |
| Time Interval Editing | 46 |
| Time of Day, Set | 44 |
| Time-of-Day | |
| Discount Vending, Set | 45 |
| Free Vending, Set | 45 |
| Inhibit Vending, Set | 45 |

U

| | |
|------------------|---|
| Unlock | |
| Mode Key | 9 |
| Payout Key | 9 |

V

| | |
|---|----|
| Validator, View Amount | 58 |
| Vends | |
| View Number of Mug | 62 |
| View Number of Test | 62 |
| View Total Paid | 56 |
| View Total Unpaid | 61 |
| View | |
| Amount in Coin Box | 57 |
| Amount in Validator | 58 |
| Cup Ring Cycles Related to SureVend | 63 |
| Cup Sizes Assigned to Selections | 52 |
| Data Three Different Ways | 54 |
| Diagnostic Messages | 68 |
| Discount Sales by Time Interval | 59 |
| Free Vends | 59 |
| Freevend Sales by Time Interval | 58 |
| Home Switch Usage Related to SureVend | 63 |
| Hot Water Tank Temperature | 38 |
| Machine Configuration Setting | 51 |
| Machine ID Number | 62 |
| Nonresettable Sales and Vend Data | 53 |
| Number of Alt Vends | 62 |
| Number of Mug Vends | 62 |
| Number of Test Vends | 62 |

Programming Procedure Index

V

View

- Number of Times No Cup Was Detected After a Cup Ring Cycled63
- Software Version43
- SureVend Average Calibration Value67
- SureVend Last Recorded Calibration Value66
- Time Data60
- Total Paid Sales 54, 55
- Total Paid Vends56
- Total Unpaid Sales61
- Total Unpaid Vends61
- Water Tank Temperature51
- Winners59
- View Cup Ring Cycles63

W

- Water Tank Temperature, View51
- Whipper, Test64
- Winner Mode, Set Up18
- Winners, View59

Y

- Year, Set44

Terms and Conditions of Sale

LIMITED WARRANTY: Subject to the limitation specified herein, all parts included on original equipment manufactured by CRANE MERCHANDISING SYSTEMS and sold to purchaser are warranted for two years from the date of shipment of the equipment in question. This warranty applies only to the original purchaser of the Merchandiser and is null and void if the Merchandiser is sold during the period of warranty.

Defective parts will be repaired or replaced free of charge when the defective part is returned, with transportation charges prepaid by purchaser, to a destination designated by CRANE MERCHANDISING SYSTEMS.

This warranty does not include any cost of service rendered or repairs made by customer or its agents on Merchandiser, or parts, unless authorization to incur such expense has been given in writing by CRANE MERCHANDISING SYSTEMS prior to incurring such expense. This warranty does not cover labor and service charges performed by CRANE MERCHANDISING SYSTEMS service technicians.

This warranty does not apply to A) electrical components, wiring, or circuits or mechanical parts or assemblies damaged as a result of operating the Merchandiser at other than the design voltage and frequency specified on the Electrical Rating Tag, or B) in event of vandalism, fire or negligence, or C) incandescent lamps, neon lamps, fluorescent lamps, ballasts, starters or other expendable items, or D) when seal is broken on electronic boards, or E) when other manufactured components are installed in CRANE MERCHANDISING SYSTEMS Merchandisers.

Replacement parts sold by CRANE MERCHANDISING SYSTEMS as After Market shall be covered for three months from the date shown on the parts invoice. Purchaser must obtain prior RETURN AUTHORIZATION for return of all parts, following guidelines given by CRANE MERCHANDISING SYSTEMS.

New, unused parts purchased as After Market can be returned within 30 days from date of parts invoice, with prior authorization from CRANE MERCHANDISING SYSTEMS.

THIS WARRANTY IS IN LIEU OF ALL OTHER WARRANTIES EXPRESS OR IMPLIED, INCLUDING WITHOUT LIMITATION, WARRANTIES OF MERCHANTABILITY OF FITNESS FOR A PARTICULAR PURPOSE. CRANE MERCHANDISING SYSTEMS SHALL NOT BE RESPONSIBLE FOR CONSEQUENTIAL OR PUNITIVE DAMAGES. CRANE MERCHANDISING SYSTEMS neither assumes nor authorizes any person to assume for it any obligation or liability in connection with the sale of said equipment or any part thereof.
